

JUMO AQUIS touch S

Modular Multichannel Measuring Device for Liquid Analysis with Integrated Controller and Paperless Recorder

Brief description

Trade fairs

The JUMO AQUIS touch S provides a central platform for the display and processing of pH value, redox voltage, electrolytic conductivity, resistance of high-purity water, temperature, quantities of disinfecting agents such as free chlorine, total chlorine, chlorine dioxide, ozone, hydrogen peroxide and peracetic acid or even flow rates. Pulse frequency inputs (counters) are available for flow measurement. Universal inputs can be used to measure almost any analog measurands using standard signals (4 to 20 mA or 0 to 10 V). The unit can measure and manage up to 25 parameters simultaneously.

Control

Besides numerous simple alarm, limit value or time-controlled switching functions, up to four higher-order control loops can be defined in the JUMO AQUIS touch S at the same time. Tried and tested JUMO control algorithms are used for P, PI, PD, and PID control in these applications.

Displays

A 5.5" TFT color screen with touch function serves to display all parameters as well as operate and setup the device. The plain text operation philosophy virtually eliminates the need for a manual. German, English, and, on request, French are included in the device at the factory as selectable user interface languages (see order details). Using the PC setup program, the language library of the unit can be expanded to as many as 15 languages. It is also possible to display languages that use Chinese and Cyrillic characters. As a result, the device is predestined for global use.

Recording

A paperless recorder is integrated for data recording. Up to 8 analog measurands and 6 binary signals are recorded and displayed on the screen in their chronological sequence. Storage is tamper-proof and enables official recording obligations to be fulfilled. The data can be extracted via JUMO PCC software or USB flash drive and evaluated using the PC evaluation software JUMO PCA3000.

Application examples

The modular setup and open structure of the device permits a host of potential applications:

- Municipal and industrial water treatment in wastewater treatment plants
- Process systems
- Drinking and bathing water monitoring
- Pharmaceutical water
- Food and beverage production (CIP/SIP plants)
- Gas scrubbers/air washers
- Cooling tower control
- Ion exchangers
- RO units (reverse osmosis)
- Power stations and energy plants
- Fish breeding
- Desalination of seawater



JUMO AQUIS touch S
type 202581/...

Special features

- Up to 4 analysis inputs in any combination for direct connection of sensors for liquid analysis
- Up to 21 further measuring signals can be connected either directly or via interface
- 2 pulse frequency inputs for flow measurement (max. 300 Hz or 10 kHz)
- Up to 17 switching outputs that are configurable as controller, switching, and alarm outputs
- Interfaces: USB host (optional), USB device, Modbus, PROFIBUS-DP, and Ethernet
- Ethernet functions: webserver, alarm alerts via e-mail, setup via PC, extraction of recorded measurement data
- Math and logic functions
- Integrated timers, washtimers, and calibration timers
- Service and operation hours counter
- Process-data recording with tamper-proof storage
- Vibrant TFT color graphics screen with 5.5" screen diagonal
- Intuitive operation via touchscreen
- Configurable user rights
- Freely configurable operation screen
- PC setup program
- Conductivity measurement for natural waters and TDS measurement
- Switchable conductivity measuring ranges for CIP/SIP plants in the beverage industry
- Compliance with pharmaceutical industry requirements to USP <645>
- Wall-mounted housing (protection type IP67) with spacious connection area

Block diagram

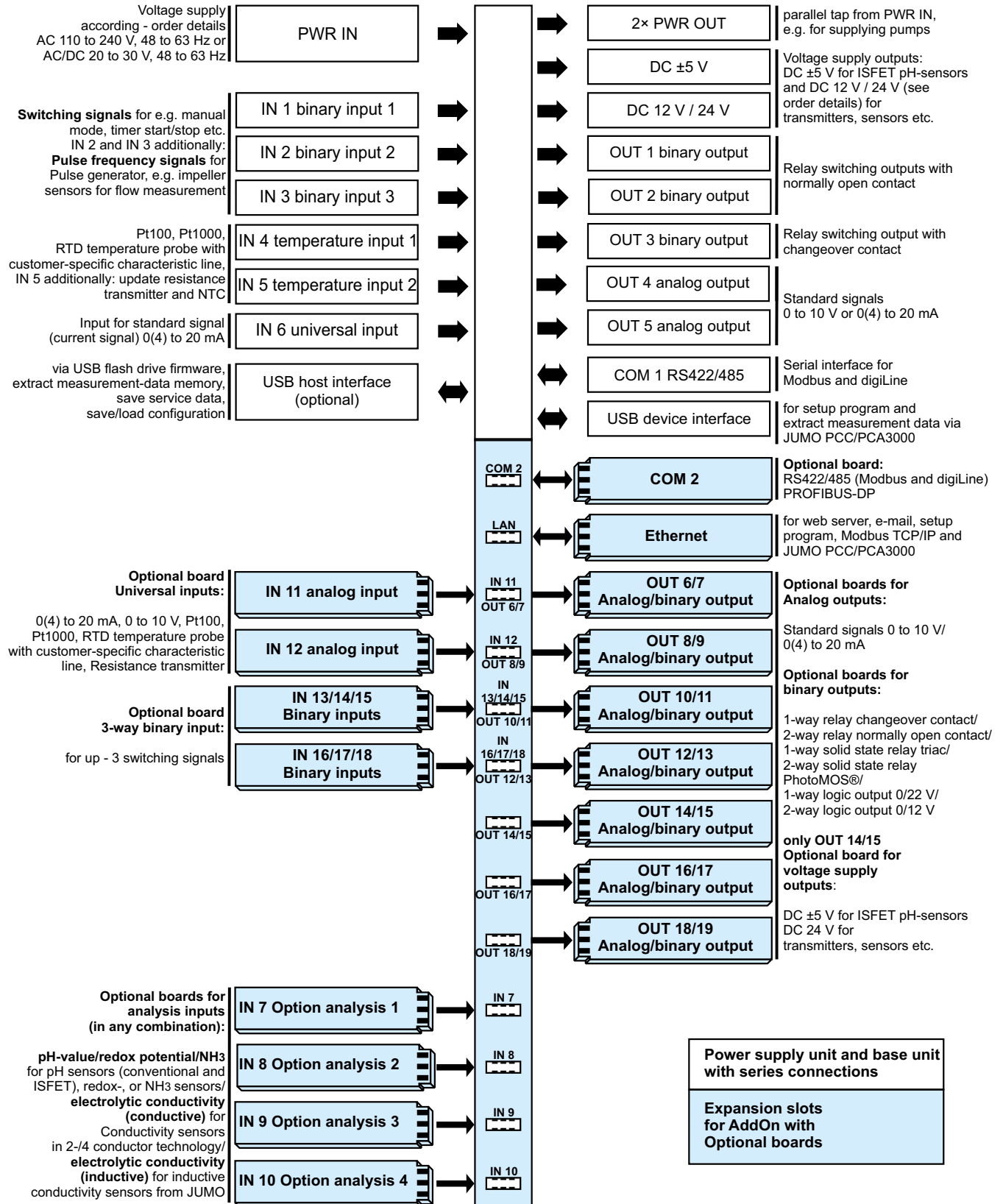

Device setup

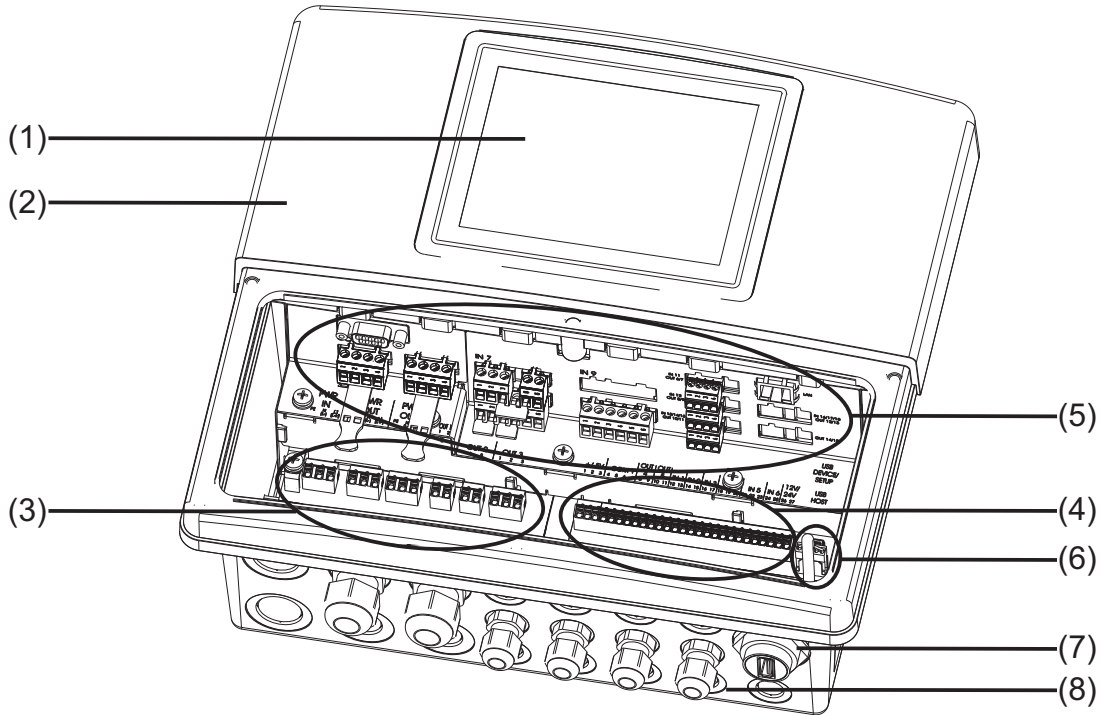

- | | |
|--|--|
| (1) TFT-touchscreen | (5) Expansion slots |
| (2) Case (terminal compartment cover opened) | (6) USB interfaces (USB device interface and connection for optional USB host socket) |
| (3) Connection terminals, power supply unit | (7) USB host socket, IP67 (also available, see "Order Details" on page 46Extra Code 269) |
| (4) Connection terminals, base unit | (8) Cable inlets |

Display and control elements

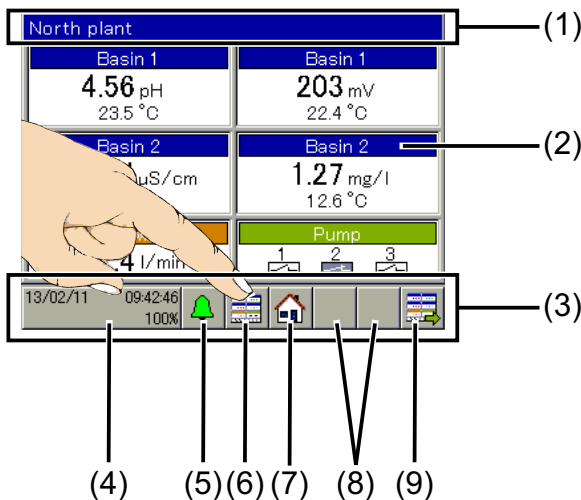

- | | |
|---|---|
| (1) Title bar | (2) Touchscreen |
| (3) Toolbar with buttons for operation | (4) "Device settings menu" button with: <ul style="list-style-type: none"> • Display of date, time • Logged-in user ("Master" in the example) • Remaining memory display in percent for recording function (in the example: 100 %) |
| (5) "Alarm/Event List" button | (6) "Select operator screen" button |
| (7) "Home" button (back to main screen) | (8) Placeholder for context-sensitive buttons (assignment based on operator screen concerned) |
| (9) "Next operator screen" button | |

Description

Operating concept

The JUMO AQUIS touch S is operated via the touch-display. Measured values, operating states and diagrams of the individual functions are displayed and visualized on up to 16 operation screens. The device functions can be controlled using the buttons on the corresponding operation screens. Touching the navigation buttons selects the operator screen to be shown. The operator displays are arranged in an operating loop and can be run in a loop via the "Next operator screen" button and selected using the "Select operator screen" button. The "Device settings menu" button is for configuration and parameterization. A further menu for viewing pending alarms and an event protocol can be opened via the "Alarm/Event list" button.

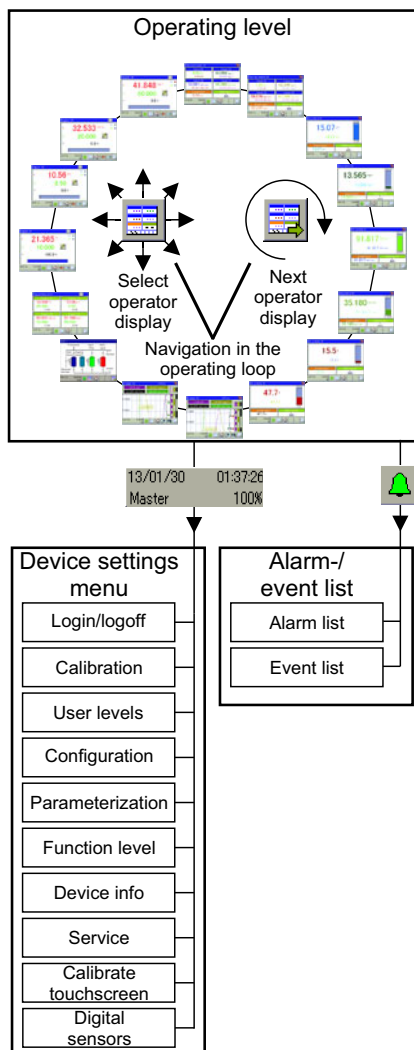

- Master:
Complete device configuration permitted
- Service:
Access for authorized service personnel
- User1/User2:
Restricted user rights

The scope of the user rights, as well as passwords and user names, can be edited via the PC setup program.

Operating loop/operation screens

The operating loop comprises 2 general screens and 6 detailed screens as standard. Further operation screens are created by configuring controllers and recording groups, thereby provisioning controller screens and diagrams in the operating loop. The individual operation screens can be configured for showing selected measured values or binary signals and for defining headings.

General screens

The general screens are pooled displays of measured values and binary signal states. For the analog measurands, 2-part screens, or 4-part screens can be configured for displaying 2 or 4 display fields, each with a main and a secondary measured value. One additional value and up to 3 binary values can also be displayed in each general screen. Headings of the display window and the display fields can be renamed. Input signals can be freely assigned to the display fields. One 4-part overview screen displays up to 9 analog and 3 binary signals.

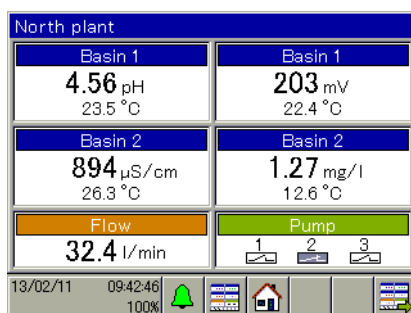

Detailed screens

The detailed screens are large-scale displays of a main measured value with a secondary measured value. One additional value and 3 binary signals can also be displayed. The main value is visualized by a bar graph. Limit values for alarm functions of the measurement input concerned are displayed by marks on the bar graph.

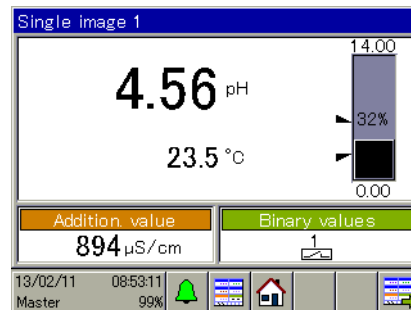

Data monitor

This function is included in the standard version. The data monitor displays measurement data as a line recorder diagram with time stamp. There are 2 groups available. For each activated group, a diagram is displayed in the operating loop as long as the group concerned is configured. 4 analog channels and 3 binary channels can be displayed per group. The measurement data are stored in a ring buffer. The oldest measurement data are overwritten to allow measurement data recording to continue when the ring buffer is full.

Recording function

This function equates to a conventional paperless recorder and is available as an extra code. It corresponds essentially to an expanded data monitor function with the following additional options:

- Display measurement data history (scroll diagram)
- Data retrieval via USB flash drive or JUMO PCC software

The measurement data histories can be retrieved via JUMO PCC software or alternatively via USB flash drive and can be displayed, evaluated, and archived using the JUMO PCA3000 PC Evaluation Software.

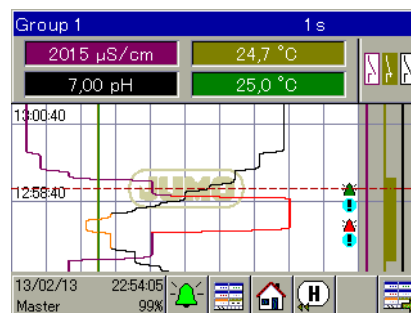

User rights

The available operating and setting options depend on the user rights of the logged-in user. The device holds 4 user accounts.

Process screen

The PC setup program is able to create a customer-specific process screen in which a global overview of the plant process can be displayed. Once created, the process screen is transferred by the PC setup program to the JUMO AQUIS touch S, where it becomes a component of the operating loop. Up to 50 items (screens, digital displays, bar graphs, texts, etc.) can be used in the process screen. Typical for a process screen:

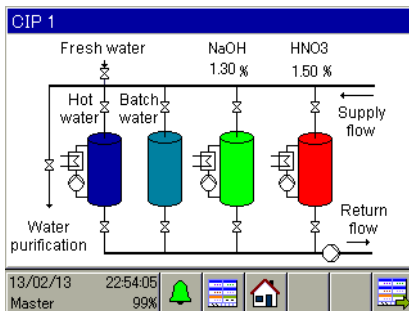

User levels

A user level is a menu which the user can access quickly and simply to define certain parameters and configuration settings. For each user level, a user-defined set of up to 50 settings can be selected using the PC setup program and saved there. Up to 16 user levels can be set up.

User level	
OK	Cancel
Device name	AQUIS touch S
Time dosing pump	00:1 0:00
Calibration interval	10 Days
Washing time pH s...	3 min
Time feed pump	00:1 0:00
Washing time CR s...	2 min

Functional level

The "Functional level" menu allows internal functions to be used and the status of these functions to be displayed. For example, counters can be reset or a wash operation started manually here.

PC setup program

The PC setup program enables the JUMO AQUIS touch S to be conveniently configured and parameterized using a PC. Data records can be created, edited, transmitted to the device and extracted in this way. The data can be saved and printed.

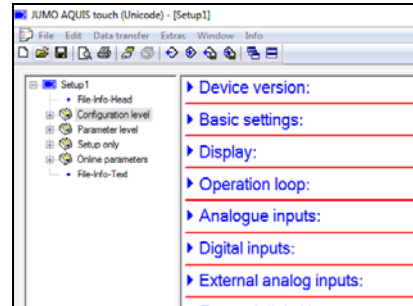

analysis inputs

Four expansion slots for analysis inputs can be flexibly equipped with optional boards for measuring pH-value, redox potential, NH₃, and electrolytic conductivity (conductive/inductive). The conductivity measurement also covers TDS and ultra-pure water applications within its performance range of services.

A compensation for numerous influencing variables (e.g. temperature) can be configured. This makes the JUMO AQUIS touch S the central measuring point for all analysis measurands in one process. The diverse range of connectable electrodes and sensors enable all process-relevant measurands to be recorded in a single device. In addition to analysis measurands, these measurands include physical measurands, such as temperature and flow, and also any measurand capable of being transferred as a pulse frequency signal or standard signal. Alarm functions ensure the monitoring of measured values for violation of upper and lower limit values. The limit values can be defined by the user.

Analog inputs

In addition to the standard temperature measuring inputs (Pt100, Pt1000, resistance transmitters/WFG, NTC etc.) and the universal input (0(4) to 20 mA) of the base unit, other analog inputs with optional boards can be made available. The optional analog inputs can be used for RTD temperature probes, resistance transmitters/WFG, voltage, and current signal. This makes the JUMO AQUIS touch S an extremely flexible tool for measuring numerous measurands. Here, too, the user can configure alarm functions for monitoring measured values for violation of upper and lower limit values.

Customer-specific linearization

In addition to the standard sensor characteristic curves installed by the factory, customer-specific linearization is available. Any arbitrary sensor characteristic curve can be input using this tool. Programming is done via the PC setup program based on value tables (up to 40 value pairs) or by inputting a 4th grade polyno-

mial.

Digital inputs

The signals from 3 standard and up to 6 digital inputs also available can be used to trigger various internal functions, switchover of a parameter block or the start of autotuning, for example.

IN 2 and IN 3 enable the frequency of encoders to be measured to perform flow measurements using impeller sensors or monitor the rotational speed of pumps, for instance. There are 2 measuring ranges available, depending on how the measuring principle in the flow function is configured:

- 3 to 300 Hz (periodic time measurement)
- 300 Hz to 10 kHz (pulse counting)

External inputs

Bus technologies enable a further 8 analog and 8 digital inputs to be employed for signal transmission with bus users.

Analog outputs

The analog outputs are freely scalable (current, voltage). They can be used to output controller outputs, setpoint values, math results, and the analog input signals (e.g. actual value).

Besides the 2 standard analog outputs of the base unit, up to 7 more with optional boards can be retrofitted.

Binary outputs

Digital outputs are switching and logic outputs. Digital outputs enable the output of alarms, limit value contacts, logic results and controller signals.

Three digital outputs are provided as standard (OUT 1 to 3 relay). A maximal of 17 digital outputs can be realized in the device by means of optional boards.

The following variants are available as optional boards:

- 1-way output relay (changeover contact)
- 2-way output relay (normally open contact)
- 1-way output solid state relay triac
- 2-way output solid state relay PhotoMOS® (wear-free control, e.g. of dosing pumps)

Limit value monitoring

In addition to the alarm functions of the measuring inputs, there are 8 limit value monitors, each with 4 selectable switching functions (min. alarm, max. alarm, alarm window, inverted alarm window) available. The limit value can be permanently configured. This function enables the monitoring of any analog values. The violation of a limit value can trigger alarms, event list entries, or switching functions. The diagrams below show the limit value functions concerned.

Min. alarm

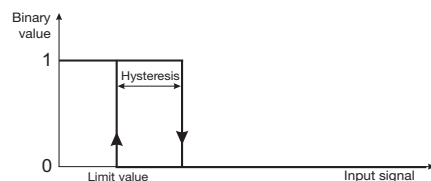

Max. alarm

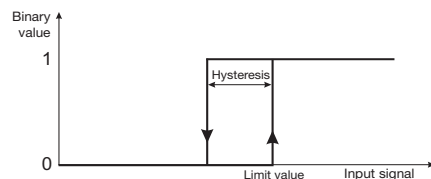

Alarm window

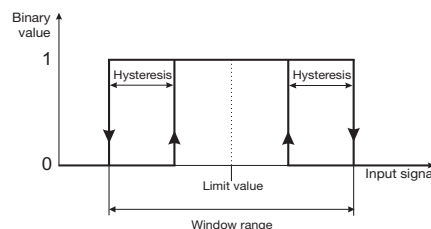

Invert alarm window

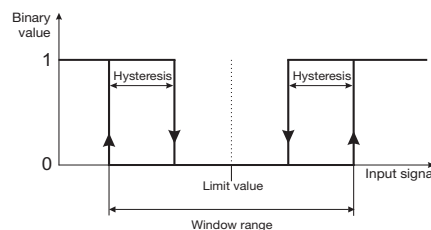

Controller

Up to 4 PID controllers can be activated at the same time. Each analog input signal (analysis size, temperature, standard signal, etc.) can be freely assigned to one of the controller channels. Ena. variable disturbance, parameter block switchover, and a coarse/fine control response enable especially stable controller behavior. The controller outputs can be configured as continuous output (output level as standard signal), pulse length output (output level as pulse length), or pulse frequency output (output level as pulse frequency).

Pulse length output

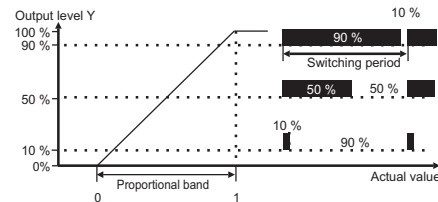

Pulse frequency output

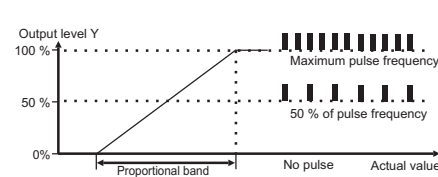

Controller detailed screens

The controller functions are visualized in detail here. Data such as actual value, setpoint value, and output level are displayed. The controller can be used in this view (manual output ratio, setpoint value input).

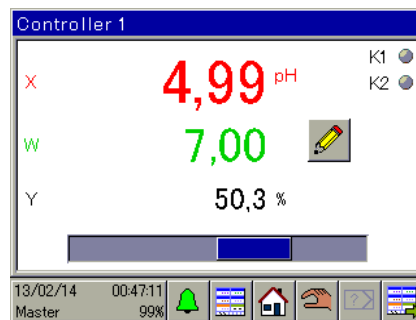

Controller general screen

If at least 2 controller channels are configured, an overview of all controllers with the most important data is displayed in the operating loop.

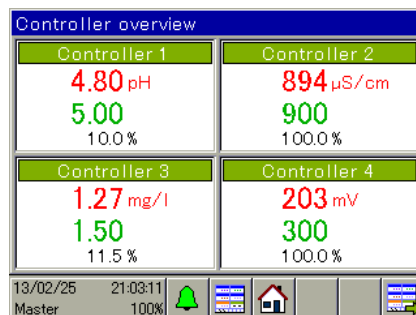

Controller parameters

Two parameter blocks can be saved for each of the 4 controller channels. Each parameter block has 25 parameters for adapting the controller to the conditions of the process concerned. Each controller can be toggled between its two parameter blocks to adapt the controller response if certain process condi-

tions change. Parameter blocks can be toggled separately for each controller channel.

Autotuning

Self-optimization also allows the user to adjust the controller to match the control path without any prior knowledge about control technology. The way the control path reacts to changes in the actuating variable is evaluated in the process. The step response method is implemented in the controller channels of the JUMO AQUIS touch S to allow autotuning.

Math and logic function

The math and logic module enables analog channels to be associated with one another, and also analog channels to be associated with counters and digital inputs. Numerous operators are available for the formulae. The JUMO PC setup program can be used to create formulae with basic arithmetic operations, root functions, power functions, logarithm functions, angle functions, and many other functions. Operators AND, OR, NOT, XOR, and edge detections are available for logic printouts. The math and logic module can be configured solely via the PC setup program. This function is available as an option.

Flow rate

Two flow measurement functions can be configured. Flow rates can be measured on the basis of the pulse signals at IN 2 or IN 3 and/or of an analog input signal. The measured flow can be integrated via the "Total quantity" function. In this way, the liquid volume that has passed over the measuring point is cumulated over a configurable period.

Counter

Four counters can be used to count activation operations or operating hours of binary functions such as alarms, digital inputs, wash timers etc. This function is intended primarily for monitoring maintenance intervals.

Timer

Twelve timer functions are included. They can be configured either as timers or time switches with a runtime.

Configured as a timer, the functions act like a time relay. The timer is controlled for starting, resetting, and stopping via binary signals. A timer can also be stopped, or its start delayed, by the tolerance band function. The tolerance band represents the deviation of a measured value from a predefined reference. If the configured deviation is exceeded, the timer concerned stops.

The chronological sequence of the timer signal can be influenced by the settings "Time", "Lead time" and "Stop time" in such a manner that a typical time relay functions (e.g. response delay or fallback delay) can be achieved.

The time switch function corresponds to a week timer. Up to 4 activation and deactivation times can be set for each weekday. When configured as a time switch with runtime, up to 4 switch-on times and runtimes can be set.

Washtimer

Two wash timers are used for the regular cleaning of electrodes. Certain functions are initiated repeatedly at an interval that can be pre-determined. For example, wash timers can control digital outputs for turning on a cleaning process in the system. By cleaning sensors on a regular basis, optimal measuring certainty can be guaranteed.

Calibration timer

The calibration timer function regularly reminds the operator to recalibrate the sensors. Corresponding alarms and event list entries can be individually configured.

Calibration logbook

Analog inputs IN 6 to IN 12 are covered by a calibration logbook in which all successfully completed calibration processes are recorded along with the date, time, and numerous other details. An overview of the calibration history on the analysis sensors is therefore available at all times.

Alarm/Event list

The alarm list reports currently pending errors. Possible alarm messages include calibration alarms or alarms triggered by input signals. Once the error sources are eliminated, alarms disappear automatically.

The event list stores and reports events, such as the appearance and disappearance of alarms, voltage supply failures, calibrations, etc. However, event list entries can also be configured in the functions of the JUMO

AQUIS touch S.

USB interfaces

Host and Device interfaces are two different kinds of USB interfaces. The Device interface is installed on the base unit as the standard location. To use the Host interface, the optional USB Host socket (see order details for extra code 269) must be installed in the device. A USB memory stick can be connected to the Host interface. This allows measurement data, Configuration data and service data to be stored. Also, memory stick configurations can be loaded into the device and device software updates can be carried out. The Device interface, together a conventional USB cable, operates the PC setup program and fetches measurement data from the optional registration function using the JUMO PCC software. The USB Device interface and the connection for the USB Host socket are both located on the base unit next to the connection terminal.

Serial interfaces RS422/485

The JUMO AQUIS touch S has a standard RS422/485 interface which can be configured for the Modbus RTU protocol (slave) or for operating JUMO digital sensors. A further interface can be retrofitted as an optional board. Standard interfaces are used to incorporate the device into an automation network via Modbus protocol or for connecting a JUMO digiLine bus with up to 6 digital sensors.

Digital sensors

One of the serial interfaces (either base unit or optional board) can be used upon activation of the extra code "JUMO digiLine protocol activated" (see order data) for operating digital sensors in a JUMO digiLine bus system. Up to 6 sensors can be operated on a JUMO digiLine bus. The JUMO digiLine protocol supports both sensors with JUMO digiLine electronics and also digital sensors in JUMO 2026xx product groups.

PROFIBUS-DP interface

The PROFIBUS-DP interface can be used to integrate the JUMO AQUIS touch S into a fieldbus system operating according to the PROFIBUS-DP standard. An application-specific GSD file, via which the JUMO AQUIS touch S is integrated into the fieldbus system, is generated by means of the project engineering tool supplied (GSD generator; GSD = basic device data (Gerätetammdaten)).

Ethernet interface

The JUMO AQUIS touch S can be integrated into a LAN via the Ethernet interface also available. This enables communication between the device and all PCs in the respective

LAN. Access to the JUMO programs, the PC setup program and the PCC communication software can be accomplished from these PCs.

Furthermore, the Ethernet interface allows the Webserver, e-mail, and Modbus TCP/IP functions to be used.

E-mail/SMS text message

The JUMO AQUIS touch S can be configured for event-controlled sending of e-mail messages. For example, this can be used to notify maintenance personnel about alarms (also via forwarding as an SMS in the e-mail SMS gateway of a mobile phone provider).

Webserver (online-visualization)

HTML documents, which can be created using a conventional HTML editor, can be stored in the JUMO AQUIS touch S using the PC setup program. These documents can contain text, graphics, and Java Script code. Analog and binary values of the JUMO AQUIS touch S can be displayed via JavaScript. The result is a website which can be retrieved over the Internet or LAN and displayed via a PC using a conventional web browser. The user can now see on this website a general representation of the system or process together with measured values and operating states. A "standard online visualization" function is stored as default. The prerequisite for observing the online visualization is a PC with an installed Microsoft® Windows® operating system and Silverlight®.

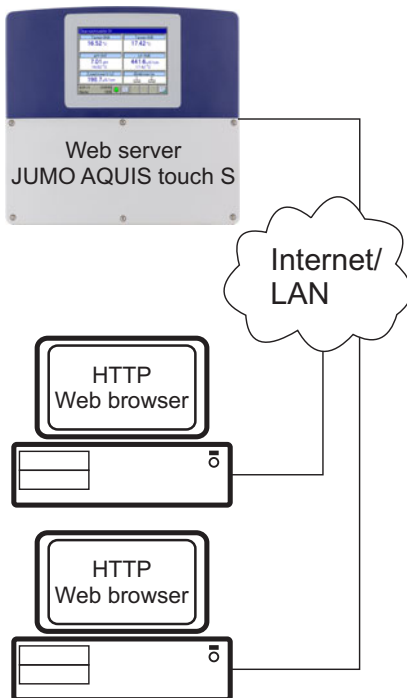

Technical data

Analog inputs base unit

Temperature measurement input (IN 4)

Probe-/Signal type	Connection type	Measuring range	Measuring accuracy	Ambient temperature influence
Pt100 DIN EN 60751	2-wire/3-wire	-200 to +850 °C	≤ 0.05 % of MR ^a	≤ 50 ppm/K
Pt1000 DIN EN 60751	2-wire/3-wire	-200 to +850 °C	≤ 0.1 % of MR ^a	≤ 50 ppm/K
RTD temperature probes with customer-specific characteristic line ^b up to 400 Ω to 4000 Ω	2-wire/3-wire 2-wire/3-wire	0 to 400 Ω 0 to 4000 Ω	≤ 0.1 % of R _{max} ^c	≤ 100 ppm/K
Sensor line resistance	maximal 30 Ω per line with 3-wire circuit			
Lead compensation	Not required for 3-wire circuit. With a 2-wire circuit, lead calibration can be executed at the respective input by means of an measured value correction with the aid of the "Offset" setting.			

^a MR: measuring range span

^b Customer-specific linearization can be used to enter a sensor characteristic line.

^c R_{max}: maximal resistance across the measuring range (400 Ω, or 4000 Ω)

Temperature measurement input (IN 5)

Probe-/Signal type	Connection type	Measuring range	Measuring accuracy	Ambient temperature influence
Pt100 DIN EN 60751	2-wire/3-wire	-200 to +850 °C	≤ 0.05 % of MR ^a	≤ 50 ppm/K
Pt1000 DIN EN 60751	2-wire/3-wire	-200 to +850 °C	≤ 0.1 % of MR ^a	≤ 50 ppm/K
Resistance transmitter	3-wire [©]	0 to 100 kΩ	0.5 % of R _{Tot} ^b	≤ 100 ppm/K
RTD temperature probes with customer-specific characteristic line ^c up to 400 Ω to 4000 Ω to 100 kΩ	2-wire/3-wire 2-wire/3-wire 2-wire/3-wire	0 to 400 Ω 0 to 4000 Ω 0 to 100 kΩ	≤ 0.1 % of R _{max} ^d	≤ 100 ppm/K
NTC 8k55	2-wire/3-wire	0 to 150 °C	≤ 0.1 % of R _{max} ^d	≤ 100 ppm/K
NTC 22k	2-wire/3-wire	0 to 150 °C		
Sensor line resistance	maximal 30 Ω per line with 3-wire circuit			
Lead compensation	Not required for 3-wire circuit. With a 2-wire circuit, lead calibration can be executed at the respective input by means of an measured value correction with the aid of the "Offset" setting.			

^a MR: measuring range span

^b R_{Tot}: total resistance of the resistance transmitter/Resistance potentiometer

^c Customer-specific linearization can be used to enter a sensor characteristic line.

^d R_{max}: maximal resistance across the measuring range (400 Ω, 4000 Ω or 100 kΩ)

Universal input (IN 6)

Signal type	Measuring range	Measuring accuracy	Ambient temperature influence
Current signal	0(4) to 20 mA	0.1 % of MR ^a	100 ppm/K

^a MR: measuring range span

Measuring circuit monitoring base unit

Inputs	Underrange/overrange
Temperature input	Yes
Universal input (current signal)	Yes

Analog inputs optional boards

Universal input (IN 11, IN 12)

Probe-/Signal type	Connection type	Measuring range	Measuring accuracy	Ambient temperature influence
Pt100 DIN EN 60751	2-wire/3-wire	-200 to +850 °C	≤ 0.05 % of MR ^a	≤ 50 ppm/K
Pt1000 DIN EN 60751	2-wire/3-wire	-200 to +850 °C	≤ 0.1 % of MR ^a	≤ 50 ppm/K
Resistance transmitter	3-wire	100 to 4000 Ω	0.5 % of R _{Tot} ^b	≤ 100 ppm/K
RTD temperature probes with customer-specific characteristic line ^c				
up to 400 Ω	2-wire/3-wire	0 to 400 Ω	≤ 0.1 % of R _{max} ^d	≤ 100 ppm/K
to 4000 Ω	2-wire/3-wire	0 to 4000 Ω		
Voltage signal	-	0 to 10 V	0.2 % of MR ^a	100 ppm/K
Current signal	-	0(4) to 20 mA	0.1 % of MR ^a	100 ppm/K
Sensor line resistance ^e	maximal 30 Ω per line with 3-wire circuit			
Lead calibration ^e	Not required for 3-wire circuit. With a 2-wire circuit, lead calibration can be executed at the respective input by means of an measured value correction with the aid of the "Offset" setting.			

^a MR: measuring range span

^b R_{Tot}: total resistance of the resistance transmitter/Resistance potentiometer

^c Customer-specific linearization can be used to enter a sensor characteristic line.

^d R_{max}: maximal resistance across the measuring range (400 Ω or 4000 Ω)

^e Specification does not apply for standard signals

Analysis input: pH/Redox/NH₃

Measurand	Measuring range	Temperature compensation	Measuring accuracy	Ambient temperature influence
pH-value (standard electrode)	-2 to 16 pH	-10 to +150 °C	≤ 0.3 % of MR ^a	0.2%/10 K
pH-value (ISFET electrode)	-2 to 16 pH	through electrode ^b		
Redox voltage	-1500 to +1500 mV	None		
NH ₃ (ammonia)	0 to 20000 ppm	-10 to +150 °C		

^a MR: measuring range span

^b ISFET electrodes supply a temperature-compensated pH-measured value.

Analysis input: CR (resistive conductivity)

Units	Display ranges ^a	Temperature compensation	Cell constant	Measuring range selection ^b	Measuring accuracy	Ambient temperature influence
μs/cm ms/cm kΩ × cm MΩ × cm	0.0000 to 9.9999 00.000 to 99.999 000.00 to 999.99 0000.0 to 9999.9 00000 to 99999	TC-linear, natural water DIN EN 27888, natural water with expanded range, TDS ^c , ASTM D-1125-95 for neutral (NaCl), acid (HCl) and alkali (NaOH) impurities	0.01 to 10 cm ⁻¹	Four measuring ranges Configurable	≤ 0.6% of MR ^d 0.3 μS × cell constant (C)	0.2%/10 K

^a The display range is scalable. The Comma format is freely configurable. An automatic decimal place can also be set.

^b Up to 4 different measuring ranges with separate display range limits, units, temperature compensation processes, and alarm functions can be configured. The respective active measuring range is selected via binary signals.

^c TDS (Total Dissolved Solids)

^d MR: measuring range span

Analysis input: Ci (conductivity, inductive)

Units	Measuring/display ranges ^a	Temperature compensation	Cell constant	Measuring range toggling ^b	Measuring accuracy	Ambient temperature influence
µS/cm mS/cm	0.0000 to 9.9999 00.000 to 99.999 000.00 to 999.99 0000.0 to 9999.9 00000 to 99999	TC-linear, ^c TC-curve, natural water, natural water with expanded temperature range, NaOH 0 to 12 %, NaOH 25 to 50 %, HNO ₃ 0 to 25 %, HNO ₃ 36 to 82 %, H ₂ SO ₄ 0 to 28 %, H ₂ SO ₄ 36 to 85 %, H ₂ SO ₄ 92 to 99 %, HCl 0 to 18 %, HCl 22 to 44 %	4.00 to 8.00 cm ⁻¹	Four measuring ranges Configurable	for 0 to 999 µS/cm: 1.5 % of MRE ^d for 1 to 500 mS/cm: 1 % of MRE ^d for 500.1 to 2000 mS/cm 1.5 % of MBE ^d	0.1 %/K

^a The display range is scalable. The Comma format is freely configurable. An automatic decimal place can also be set.

^b Up to 4 different measuring ranges with separate display range limits, units, temperature compensation processes, and alarm functions can be configured. The respective currently active measuring range is selected via binary signals.

^c TC: temperature coefficient

^d MRE: Measuring range end value

Temperature compensations

Compensation type	Compensation range
Linear TC ^a	-50 to +250 °C
TC curve	-50 to +250 °C
TDS	-50 to +250 °C
natural water according to DIN EN 27888	0 to 36 °C
natural water with expanded temperature range ^b	0 to 100 °C
ASTM D-1125-95 (neutral, alkaline, and acidic impurities)	0 to 100 °C
NaOH 0 to 12 %	0 to 90 °C
NaOH 25 to 50 %	10 to 90 °C
HNO ₃ 0 to 25 %	0 to 80 °C
HNO ₃ 36 to 82 %	-20 to +65 °C
H ₂ SO ₄ 0 to 28 %	-17 to +104 °C
H ₂ SO ₄ 36 to 85 %	-17 to +115 °C
H ₂ SO ₄ 92 to 99 %	-17 to +115 °C
HCl 0 to 18 %	10 to 65 °C
HCl 22 to 44 %	-20 to +65 °C

^a TC: temperature coefficient

^b The temperature compensation "natural water with expanded temperature range" extends beyond the standardized temperature thresholds of DIN EN 27888.

Measuring circuit monitoring, optional boards

Input/Sensor	Underrange/over-range	Short circuit/sensor break	open circuit	Detection of deposits
pH-value (glass electrode)	Yes	Configurable Impedance measurement ^a	Configurable Impedance measurement ^a	-
pH-value (ISFET)	Yes	No ^b	No ^b	-
Resistive conductivity	Yes	No ^b	Configurable	Only with 4-wire circuit ^a
Inductive conductivity	Yes	No ^b	No ^b	-
Universal input for connection of: voltage/current signal, RTD temperature probe	Yes	No ^b	No ^b	-
Universal input for connection of: resistance transmitter	No ^b	No ^b	No ^b	-

^a With impedance monitoring and detection of deposits, the sensor alarm is tripped in case of a fault. Monitoring via impedance measurement can also be activated.

The following points should be observed to ensure correct function:

- Impedance measurements are possible only with glass-based sensors.
- Sensors must be connected directly to an analysis input for pH/Redox/NH₃ on the device.
- Impedance converters must not be installed in the measuring circuit.
- The maximal admissible cable length between sensor and device is 10 m.
- Liquid resistance has a direct impact on the measurement result. It is therefore

advisable to activate the impedance measurement in liquids at a minimum conductivity of approx. 100 µS/cm.

^b Errors in the measuring circuit (short circuit or line break) lead to display errors (underrange or overrange or inadmissible value).

Analog outputs of base unit and optional boards

Signal type	Signal range	Admissible load resistance	Accuracy	Ambient temperature influence
Voltage signal	0 to 10 V	> 500 Ω	≤ 0.25 %	≤ 100 ppm / K
Current signal	0/4 to 20 mA	< 450 Ω	≤ 0.25 %	≤ 100 ppm / K

Digital inputs base unit

Designation	Input frequency ranges	Min. pulse duration		Signal type	Switching thresholds ^a	
		On	Off		On	Off
IN 1 ^b	≤ 1 Hz	300 ms	300 ms	Configurable as: "Potential-free contact" or "Ext. voltage supply" (maximal 28 V)	> 8 V	< 5 V
IN 2 to 3 ^{b,c} Switching signal	≤ 1 Hz	30 µs	30 µs		> 1.8 mA	< 1.2 mA
IN 2 to 3 ^{b,c} Flow	3 to 300 Hz 300 Hz to 10 kHz	30 µs	30 µs			

^a This specification is relevant only if "Ext. voltage supply" option is selected from the "Contact" option in the Configuration. Sensors and transmitters should be supplied from voltage supply outputs on the JUMO AQUIS touch S. An externally supplied voltage signal must not have a voltage over 28 V.

^b All digital inputs IN 1 to 3 are suitable for connecting proximity switches. Recommended types are: Wachendorff P2C2B1208NO3A2 and Balluff BES M12EG-PSC80F-BP03.

^c Digital inputs IN 2 and IN 3 can be used for impeller flow sensors (water meters) or magnetic-inductive flow meters, for example. The input frequency depends on the configured measurement principle in the flow function.

Digital inputs optional boards

Max. number of retrofittable digital inputs	Max. pulse frequency	Min. pulse duration		Signal type
		On	Off	
Max. 2 optional boards with 3 digital inputs each	1 Hz	300 ms	300 ms	Potential-free contact

Digital outputs, power supply unit board

Designation	Switching output	Ampacity at resistive load	Contact life ^a

大華高科股份有限公司

www.taiwah.com.tw info@taiwah.com.tw

台 TEL: (02)2592-5119
北 FAX: (02)2592-3577

台 TEL: (04)2707-2269
中 FAX: (04)2707-1799

台 TEL: (06)243-2338
南 FAX: (06)243-2339



Data sheet 202581

Page 13/50

OUT 1	Relay, normally open contact	3 A at AC 250 V	150,000 switching cycles
OUT 2	Relay, normally open contact		
OUT 3	Relay, changeover contact		

^a The maximal ampacity of the contacts must not be exceeded.

Digital outputs, optional boards

Optional card	Switching output	Max. current	Contact life ^a	Special features
Relay output 2-way Normally Open Contact	2 normally open con- tacts ^b	3 A at AC 250 V	150,000 switching cy- cles	-
Relay output, single Changeover contact	1 changeover contact			-
Solid state relay triac	Switching output with triac (protected by Va- ristor) ^c	1 A at AC 230 V	Wear-free	-
Solid state relay PhotoMOS®	Switching output with PhotoMOS®	200 mA at DC 45 V and/or AC 30 V	Wear-free	not short-circuit-proof; max. voltage DC 45 V AC 30 V
Logic output 0/12 V	High/low signal	20 mA ^d	Wear-free	-
Logic output 0/22 V	High/low signal	30 mA ^d	Wear-free	-

^a The maximal ampacity of the contacts must not be exceeded.

^b Combining a mains voltage circuit with a protective low-voltage circuit on the "dual normally open contact" option is not admissible.

^c A varistor protects the Triac against excessive voltages, such as can occur during switching processes.

^d Current limiting via the logic output of the device

Voltage supply outputs base unit

Designation	Output voltage	Ampacity	Connection
DC 12 V/24 V voltage supply ^a (e.g. for external transmitters)	DC 12 V +15 / -25 %	25 mA	Spring-cage terminals
	DC 24 V +5 / -5 %	42 mA	
DC ±5 V voltage supply (e.g. for IS- FET pH-sensors)	DC +5 V +10 / 0 %	200 mA	
	DC -5 V ±15 %	40 mA	

^a based on order code

Voltage supply outputs, power supply unit board

Designation	Output voltage	Total ampacity ^a	Connection
PWR OUT	AC 110 to 240 V +10 / -15 %; 48 to 63 Hz or AC/DC 20 to 30 V; 48 to 63 Hz	4 A	Spring-cage terminals

^a The sum total of the output currents for the two PWR OUT connections must not exceed the total ampacity.

Voltage supply outputs, optional board

Designation	Output voltage	Ampacity	Connection
DC 24 V voltage supply (e.g. for external transmitters) ^a	DC 24 V +5 / -5 %	42 mA	screw terminals
DC ±5 V voltage supply (e.g. for IS- FET pH-sensors)	DC +5 V +10 / 0 % (between terminals 3 and 4)	150 mA	
	DC -5 V ±15 % (between terminals 5 and 4)	30 mA	

^a An optional board for voltage supply outputs accommodates all the outputs listed in this table. A maximal of 1 such optional board can be integrated into a device.

Interfaces

Serial Interface RS422/485 (base unit and optional board)

Protocol	Data formats ^a	Device addresses	Baud rates in baud	Connection
Modbus (slave) Modbus digital sensors	8 - 1 - no parity 8 - 1 - odd parity 8 - 1 - even parity	1 to 254	9600 19200 38400	Base unit: Spring-cage terminals Option: screw terminals

^a Specification in useful bit - stop bit - parity format. Therefore, the frame always comprises 8 useful bits and 1 stop bit. Only the parity is differentiated.

Sampling rates for digital sensors

with up to 2 digital sensors with baudrate = 9600 and generally with baud rate > 9600 baud ^a	500 ms
at baud rate = 9600 baud and more than 2 digital sensors on the bus ^b	1 s

^a Baud rates above 9600 are supported only by JUMO tecLine sensors and JUMO sensors with JUMO digiLine electronics. JUMO ecoLine sensors support only a baud rate of 9600.

^b For JUMO ecoLine O-DO sensors, the sample rate can be adjusted (1 to 999 s).

PROFIBUS-DP (optional board)

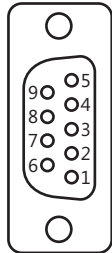
Protocol	Data formats ^a	Device addresses	Baud rates	Connection
DP-V0	Big Endian Little Endian	0 to 127	9.6 kBaud to 12 MBaud	D-sub socket 9-pole 

^a Big Endian corresponds to the Motorola® data format and Little Endian to Intel® data format.

Ethernet optional board (10/100Base-T)

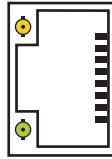
Function	Use	Application protocol/ program	Special features	Connection
Web server	Online-visualization via web browser	HTTP	Editable via HTML Editor	RJ 45 socket 
E-mail/SMS text message ^a	E-mail dispatch via SMTP server Transmission as SMS text message	SMTP	Five e-mail templates can be stored, up to 3 receivers for each e-mail template	
Modbus TCP/IP	Process data exchange with Modbus users ^b	Modbus TCP/IP	TCP Port: 502	
Automatic IP configuration	Network administration ^c	DHCP	-	
Setup via PC	Device settings via PC setup program	JUMO PC setup program (HTTP)	-	
Recording function ^d	Extract, archive, evaluate measurement data	JUMO PCC and PCA 3000	-	



^a The e-mail function allows the device, triggered by internal and/or external binary signals, to send hard-programmed messages. This requires the data of an SMTP server (e-mail intermediate server) to be known. The e-mail function can be configured exclusively via the PC setup program.

^b Modbus TCP/IP enables Modbus users to communicate via a LAN, provided this is connected to the LAN (e.g. via gateways). To configure a Modbus communication, you will require the interface description for the JUMO AQUIS touch S.

^c Enlist the help of your network administrator or an IT specialist for the IP configuration.

^d The recording function stores measurement data in a ring buffer inside the device. Further details appear on Page 17.

USB interfaces base unit

Interface	Use	Support	Connection	Version
USB host interface (optional ^a)	Extract measurement data memory ^b , Read/write device settings, Save service data ^c Update the firmware	USB flash drive	USB port type A 	USB 2.0
USB device interface	Device setting via PC setup program, Extract, archive, evaluate measurement data	JUMO PC setup program, JUMO PCC/PCA3000 software	USB port type Mini-B 	

^a Use requires the USB host socket (see "Order Details" on page 46, Extra Code 269).

^b The recording function stores measurement data in a ring buffer inside the device. Further details appear on Page 17.

^c Service data can be stored on a USB flash drive for diagnostic purposes.

Electrical data

Voltage supply (switch-mode)	AC 110 to 240 V +10 / -15 %; 48 to 63 Hz or AC/DC 20 to 30 V; 48 to 63 Hz
electrical safety	According to EN 61010, part 1 overvoltage category III, pollution degree 2
Max. power consumption AC 110 to 240 V AC/DC 20 to 30 V	53.7 VA 26.2 VA
Data backup	Flash memory
Electrical connection	Spring-cage terminals and screw terminals Specifications for conductor cross sections on Page 18
Electromagnetic compatibility (EMC): Interference emission Interference immunity	DIN EN 61326-1 Class A – only for industrial use – Industrial requirements

Screen Touchscreen

Type	TFT-touchscreen
Touchscreen sensors	Resistive (can also be operated wearing gloves)
Display protection	Plastic film for protection against damage and scratches
Size	5.5"
Resolution	320 × 240 pixel
Color depth	256 colors
Viewing angle	Horizontal: ±70° Vertical: -70 to +50°

Housing

geographic height for operation	maximum 2000 m above sea level
Case type	Surface-mounted case made of plastic (ABS) for indoor use only
Materials	Terminal compartment cover screws: 1.4567 stainless steel Mounting plate: 1.4301 stainless steel
Dimensions	301.5 mm × 283.2 mm × 120.5 mm
Ambient temperature	-5 to +50 °C on device version with voltage supply AC 110 to 240 V -5 to +45 °C on device version with voltage supply AC/DC 20 to 30 V
Storage temperature	-30 to +70 °C
Resistance to climatic conditions	Relative humidity < 92 % annual average, no condensation
Operating position	Any (with due consideration for the viewing angle of the screen)
Protection type Closed case Open case	According to DIN EN 60529 IP67 IP20
Cable inlets Scope of delivery Standard version Full configuration kit (see accessories)	Cable fittings: 6× M12 × 1.5 3× M16 × 1.5 Cable fittings: 9× M12 × 1.5 2× M16 × 1.5 2× M20 × 1.5
Weight without holder for wall mounting (fully configured)	3390 g
Weight of holder for wall mounting	790 g
Installation torques for the cable fittings	0.7 Nm for M12 × 1.5 2 Nm for M16 × 1.5 2.7 Nm for M20 × 1.5

Functions

Controller channels

Number	4
Controller type	Two-state controller Three-state controller Continuous controller Coarse/fine controller Three-step controller proportional controller with integrated actuator driver
Controller structure	P, PI, PD, PID
Controller outputs	for each controller channel, 2 outputs configurable as: Pulse length output, pulse frequency output (maximal 240 pulses per minute), continuous output
Disturbance feedforward control	multiplicative and/or additive ^a
Autotuning	Step response method
Sampling rate	250 ms

^a Ena. variable disturbance permits consideration of influencing variables in the process environment beyond the actual value alone. This keeps the control response stable, even when fluctuations in such ambient conditions occur.

Recording function

	Data monitor	Recording function (also available)
Number of groups ^a	2	2
Number of input variables per group	4× analog 3× digital	4× analog 3× digital
Recording/memory cycles	1 to 3600 s	1 to 3600 s
Memory values	Current value Average value Minimum value Maximum value	Current value Average value Minimum value Maximum value
Size of the ring buffer ^b	sufficient for 150 entries ^c	Sufficient for approx. 31 million entries ^c
History function ^d	No	Yes
Archiving/evaluation	No	Yes (via JUMO PCA3000 evaluation software)

^a A freely configurable set of input variables can be pooled in one group. Each group has its own display screen. The group affiliation is considered for data storage, to enable evaluation via PC.

^b The measurement data are stored in a ring buffer. When the ring buffer is full, the recording function begins at the start of the ring buffer by overwriting the measured value history.

^c The specification relates to 4 analog values and 3 binary values per entry and aids orientation. The sum total of both groups is indicated.

^d The history function allows you to scroll through the diagram to past recording times. All measurement data stored in the ring buffer can therefore be viewed on the device.

Customer-specific linearization

Number of grid points ^a	up to 40 value pairs
Interpolation ^b	Linear
Formula entry ^c	4th degree polynomial

^a An approximate characteristic line can be entered by inputting grid points (value pairs of the customer-specific characteristic line).

^b Linear interpolation means the formation of a slope function through 2 grid points.

^c As an alternative to entering support points, a customer-specific characteristic curve can also be entered as a formula in the form of a polynomial.

Approvals/approval marks

Approval mark	Test facility	Certificate/certification numbers	Inspection basis	Valid for
c UL us	Underwriters Laboratories	E201387	UL 61010-1 (3rd edition), CAN/CSA-C22.2 No. 61010-1 (3rd edition)	Type 202581/...

Connection diagram

The connection diagram in the data sheet provides preliminary information about the connection options. For the electrical connection, only use the installation instructions or the operating manual. The knowledge and the correct technical execution of the safety information/instructions contained in these documents are mandatory for installation, electrical connection, startup, and for safety during operation.

Important information on conductor cross-sections and ferrules

Ferrule	Conductor cross section		Minimum length of ferrule or stripping
	minimal	Maximum	
without ferrule			
Power supply unit	0.2 mm ²	1 mm ²	8 mm
Base unit	0.2 mm ²	1 mm ²	8 mm
with ferrule without lip			
Power supply unit	0.25 mm ²	0.75 mm ²	8 mm
Base unit	0.25 mm ²	0.75 mm ²	8 mm
with ferrule with lip			
Power supply unit	0.25 mm ²	0.75 mm ²	8 mm
Base unit	0.25 mm ²	0.75 mm ²	8 mm
Rigid			
Power supply unit	0.2 mm ²	1.5 mm ²	8 mm
Base unit	0.2 mm ²	1.5 mm ²	8 mm

Conductor cross-sections for optional boards

The terminals on optional boards are plug-in screw terminals.

Optional boards for	Ferrule	Conductor cross section		Length to strip
		minimal	Maximum	
Universal inputs	without ferrule	0.14 mm ²	1.5 mm ²	7 mm
Analog outputs	with ferrule with lip	0.25 mm ²	0.5 mm ²	7 mm
Digital inputs				
Digital outputs PhotoMOS®	Ferrule without lip	0.25 mm ²	1.5 mm ²	7 mm
Logic outputs				
Voltage supply output	Rigid	0.14 mm ²	1.5 mm ²	7 mm
Analysis input pH/redox/NH ₃	without ferrule	0.2 mm ²	2.5 mm ²	7 mm
CR analysis inputs ^a	with ferrule with lip	0.25 mm ²	1.5 mm ²	7 mm
Analysis inputs Ci ^b	Ferrule without lip	0.25 mm ²	2.5 mm ²	7 mm
Digital outputs relay				
Digital outputs triac	Rigid	0.2 mm ²	2.5 mm ²	7 mm

^a CR analysis inputs = Analysis inputs for resistive conductivity

^b Analysis inputs Ci = Analysis inputs for inductive conductivity

Overview of connections

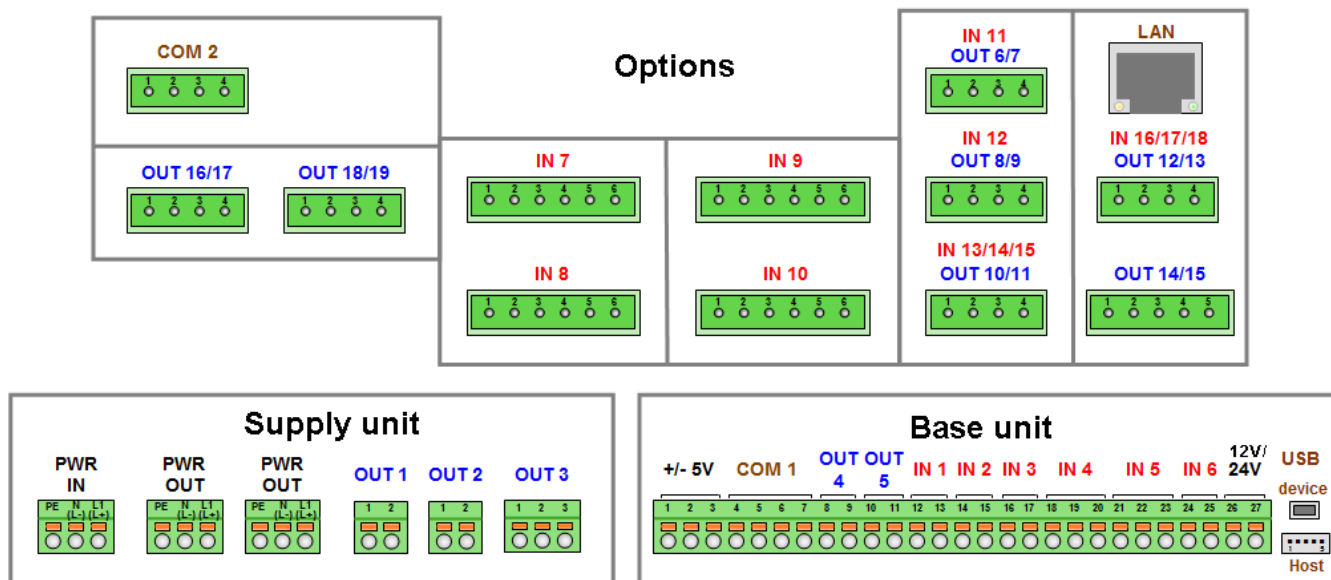

	Assembly	Connector terminal	Type
Inputs	Base unit	PWR IN	Voltage supply for the device
		IN 1 to IN 3	Digital inputs
		IN 4 to IN 5	Temperature inputs
		IN 6	Universal input
	Optional boards	IN 7 to IN 10	analysis inputs
		IN 11 to IN 12	Universal inputs
IN 13 to IN 18		Digital inputs	
Outputs	Power supply unit	PWR OUT	Mains voltage lead out
		OUT 1 to 2	Relay outputs normally open contact
		OUT 3	Relay outputs changeover contact
	Base unit	OUT 4 to OUT 5	Analog output
		±5 V	Voltage supply output ±5 V for ISFET sensors
		12 V / 24 V	Voltage supply output DC 12 V / 24 V (e.g. for external transmitters) ^a
	Optional boards	OUT 6 to OUT 19	Analog/digital outputs, OUT 14/15 also for voltage supply output DC ±5 V, 24 V
Interfaces	Base unit	COM 1	RS422/485
		USB device interface	USB device interface
		USB host interface connection ^b	USB host interface connection ^b
	Optional boards	COM 2	PROFIBUS-DP or RS422/485
		LAN	Ethernet

^a The desired output voltage must be stated on the order (see order details).

^b Use requires the USB host socket (see "Order Details" on page 46, Extra Code 269).

Analog inputs base unit

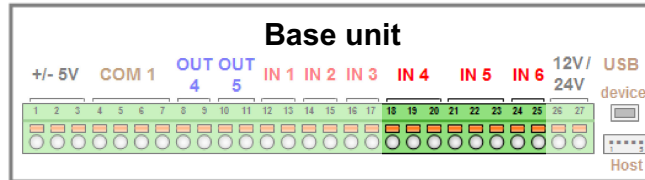

Connector/terminal	Connection variant	Symbol
IN 4	RTD temperature probe 2-wire circuit Pt100, Pt1000 or customer-specific characteristic line	
	RTD temperature probe 3-wire circuit Pt100, Pt1000 or customer-specific characteristic line	
IN 5	RTD temperature probe 2-wire circuit Pt100, Pt1000 or customer-specific characteristic line	
	RTD temperature probe 3-wire circuit Pt100, Pt1000 or customer-specific characteristic line	
	NTC 2-wire circuit	
	NTC 3-wire circuit	
	Resistance transmitter A = Start E = End S = Slider	
IN 6	Standard signal Current 0(4) to 20 mA	

Analog inputs optional boards

Universal inputs

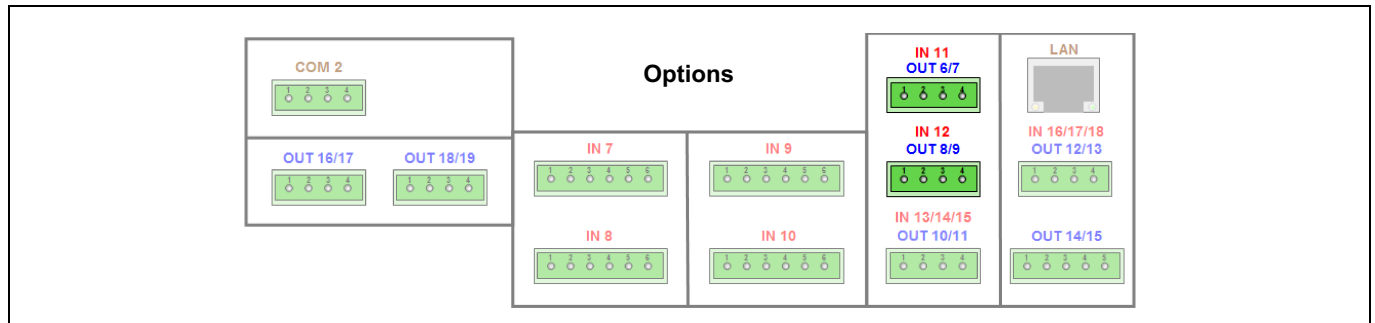

Slot	Connection variant	Symbol
IN 11 IN 12	RTD temperature probe 2-wire circuit Pt100, Pt1000 or customer-specific characteristic line	
	RTD temperature probe 3-wire circuit Pt100, Pt1000 or customer-specific characteristic line	
	Resistance transmitter A = Start E = End S = Slider	
	Standard signal Voltage 0 to 10 V	
	Standard signal Current 0(4) to 20 mA	

pH/Redox/NH3 analysis inputs

For optional board "analysis pH/Redox/NH3", 2 versions are currently in circulation. The connection diagram takes into consideration the connection terminal layout of both Version I and of Version II. To identify the version of your optional board, compare the connection terminal layout to the following illustrations:

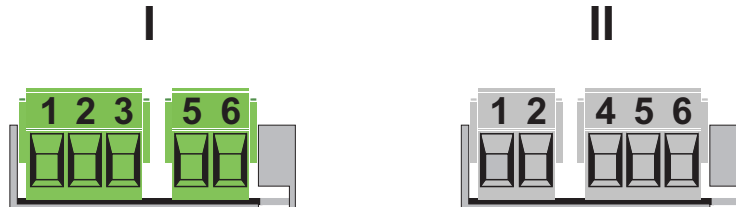

I = First version

II = Revised version

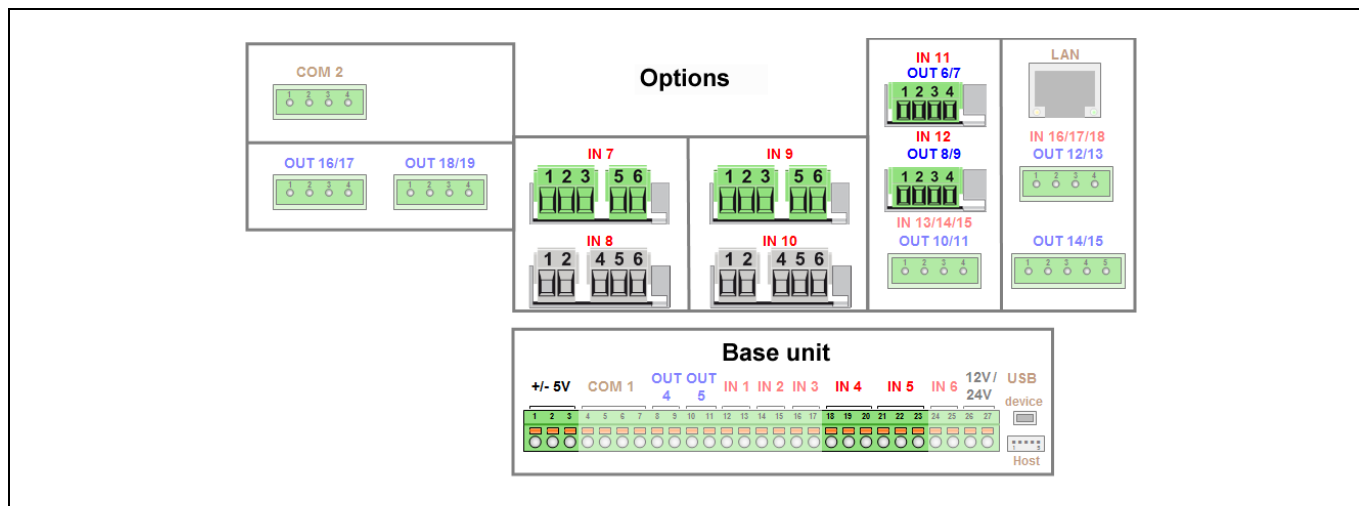

Slot	Option/connection variant	Wire (color) ^a	Potential	Terminal			Symbol	
				DC ±5 V	Temperature input	Analysis input pH/redox		
						I		I
IN 7 IN 8 IN 9 IN 10	ISFET-pH sensor	A (blue)	DC +5 V	1				
		B (black)	GND with jumper to F	2				
		C (green)	DC -5 V	3				
		D (white/black)	Ion-sensitive gate			1		1
		E	Bypass			3		4
		F (yellow)	Reference			5		5
		G (white)	Compensation thermometer in 3-wire circuit			6		6
		H (red/black)						
		I (red)						
				Connection ^b 				
The RTD temperature probe can be connected to a temperature input or universal input. ^c The connection terminal numbers are provided on the connection diagram for the selected analog input.								

^a The conductor colors listed refer to JUMO ISFET-pH sensors. The orange-colored conductor is not connected.

^b The connection diagram for the selected analog input must be observed when connecting the temperature probe.

^c When connecting the temperature probe of the JUMO ISFET-pH sensor with process connection 615 (NTC 8k55), no customer-specific linearization is required as it is with the JUMO AQUIS 500 pH. The temperature input IN 5 supports the connection of 8k55-NTC temperature sensors.

Options

Slot	Option/connection variant	Wire (color)	Potential	Terminal		Symbol		
				Temperature input	Analysis input			
					pH/redox			
				I	I			
IN 7	pH/Redox Asymmetric connection of a combination electrode (Standard connection variant) For temperature compensation, a separate temperature sensor can be connected to an analog input.	A (core)	Glass/metal electrode		1	1		
IN 8		B (jumper)	-		3	4		
IN 9						5		5
IN 10		C (shield)	Reference electrode			6		6

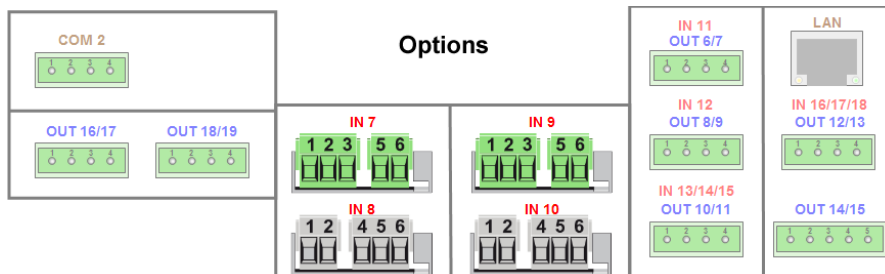

Slot	Option/connection variant	Wire (color)	Potential	Terminal		Symbol	
				Temperature input	Analysis input pH/redox		
					I		I
IN 7 IN 8 IN 9 IN 10	pH/Redox Asymmetric connection of a combination electrode with integrated RTD temperature probe and VarioPin terminal head	A (core)	Glass/metal electrode		1	1	
		B (inner shield)	Reference electrode		3	4	
		C (gray)	Pt100/1000	Connection ^a 			
		D (blue)	Not used				
		E (white)	Pt100/1000				
		F (green)	Pt100/1000				
		S (outer shield)	Shield		6	6	

The RTD temperature probe is used to provide a temperature-compensated pH-value measurement, and can be connected to a temperature input or universal input.

Terminal 2 at the analysis input is not connected!

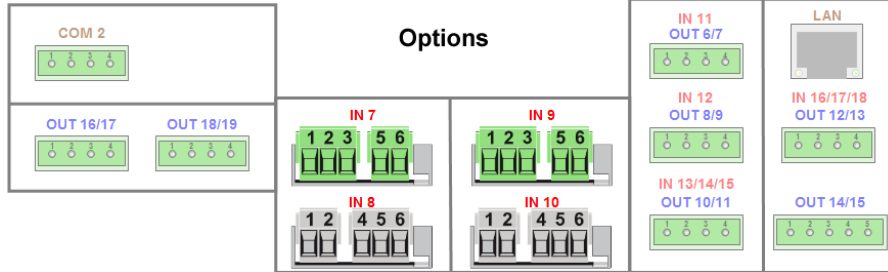

Slot	Option/connection variant	Wire (color)	Potential	Terminal		Symbol	
				Temperature input	Analysis input pH/redox		
					I		I
IN 7 IN 8 IN 9 IN 10	pH/Redox	A (core)	Glass/metal electrode		1	1	
	Symmetric connection of a combination electrode	B (inner shield)	Reference electrode		3	4	
		C (grounding pin, pipe or tank wall at the measuring point)	Liquid potential		5	5	
		D (outer shield)	Shield		6	6	
<p>Symmetric connection is used to reduce interference from stray electromagnetic fields along the sensor cable.</p> <p>Terminal 2 at the analysis input is not connected!</p>							

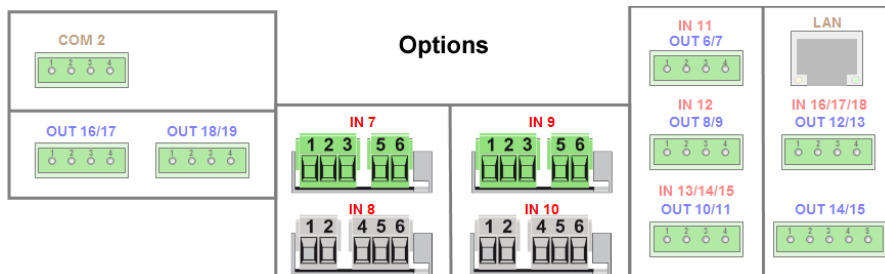

Slot	Option/connection variant	Wire (color)	Potential	Terminal		Symbol	
				Temperature input	Analysis input pH/redox		
					I		I
IN 7 IN 8 IN 9 IN 10	pH/Redox Symmetric connection of a combination electrode with integrated RTD temperature probe and Vario-Pin terminal head	A (core)	Glass/metal electrode		1	1	
		B (inner shield)	Reference electrode		3	4	
		C (gray)	Pt100/1000	Connection ^a 			
		D (blue)	Not used				
		E (white)	Pt100/1000				
		F (green)	Pt100/1000				
		G (grounding pin, pipe or tank wall at the measuring point)	Liquid potential		5	5	
S (outer shield)	Shield		6	6			
<p>Symmetric connection is used to reduce interference from stray electromagnetic fields along the sensor cable.</p> <p>The RTD temperature probe is used to provide a temperature-compensated pH-value measurement, and can be connected to a temperature input or universal input.</p> <p>Terminal 2 at the analysis input is not connected!</p>							

^a The connection diagram for the selected analog input must be observed when connecting the temperature probe.

Electrolytic conductivity analysis inputs

Options		
IN 7 IN 8 IN 9 IN 10	Ci optional board (inductive conductivity measurement) Connection via M12 connector, connect compensation thermometer connections (2-core cable of connection socket) to a suitable analog input (2-wire circuit), The factory-installed wiring must not be changed! Core colors of the conductor connection of the M12 socket to the screw terminal connection on the optional board: A = Brown B = White C = Pink D = Silver E = Black F = Green (temperature sensor) G = Yellow (temperature sensor)	
	CR optional board (conductive conductivity measurement) 2-electrode system with 2-wire conductor with concentric conductivity sensors, terminal 1 must be connected to the outer electrode. A = Outer electrode (core color for JUMO types with fixed cable: White) B = Inner electrode (core color for JUMO types with fixed cable: Brown) C = Shield	
	CR optional board (conductive conductivity measurement) 2-electrode system with 4-wire conductor (Wiring to minimize the measuring error caused by line resistance) with concentric conductivity sensors, terminal 1 must be connected to the outer electrode. A/B = Outer electrode C/D = Inner electrode E = Shield	

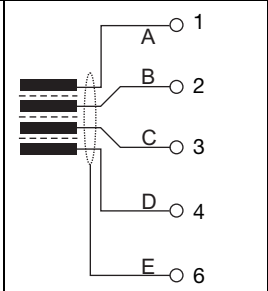
<p>IN 7 IN 8 IN 9 IN 10</p>	<p>CR optional board (conductive conductivity measurement) 4-electrode system</p> <p>A = Outer electrode 1 (I hi) (core color of CR-4P cable for JUMO types: Red) B = Inner electrode 1 (U hi) (core color of CR-4P cable for JUMO types: Gray) C = Inner electrode 2 (U lo) (core color of CR-4P cable for JUMO types: Pink) D = Outer electrode 2 (I lo) (core color of CR-4P cable for JUMO types: Blue) E = Shield</p>	
---	--	---

Binary inputs

Base unit

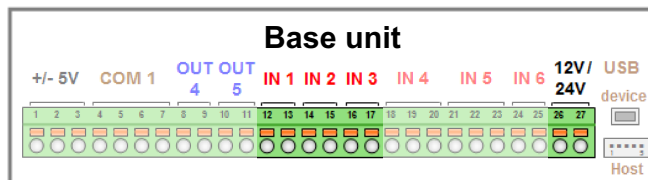

Connector/ terminal	Connection variant	Wire	Potential	Terminal			Symbol	
				12 V / 24 V	IN 1	IN 2		IN 3
IN 1 to 3	Digital input (potential-free contact)	A	Potential-free contact		12	14	16	
		W	contact		13	15	17	
In the digital input configuration, the "Contact" option must be set to "Potential-free contact".								
	Digital input (logic signal)	A	Logic signal +		12	14	16	
		W	Logic signal -		13	15	17	
In the digital input configuration, the "Contact" option must be set to "Ext. voltage supply".								
	Digital input (NPN transistor switching output) ^a	A	Switching signal (collector)		12	14	16	
		W	Sensor -		13	15	17	
		C ^b	Sensor +	26				
		D ^b	Sensor -	27				
In the digital input configuration, the "Contact" option must be set to "Potential-free contact".								
	Digital input (PNP transistor switching output) ^b	A	Switching signal (collector)		12	14	16	
		W	Sensor -		13	15	17	
		C ^b	Sensor +	26				
		D ^b	Sensor -	27				
In the digital input configuration, the "Contact" option must be set to "Ext. voltage supply".								

^a The connection variants for transistor switching outputs (NPN / PNP) are especially important for the flow measurement via impeller sensor (type 406020, parts no. 00525530, 00525531) at inputs IN 2 and IN 3 (pulse frequency inputs). However, alternative sensors with transistor switching output can also be connected.

^b The voltage supply output on the base unit is available for the DC 12 V / 24 V voltage supply to sensors.

Optional boards

Options		
Connector/terminal	Connection variant	Symbol
IN 13/14/15 IN 16/17/18	3× binary input (potential-free contact)	

Digital outputs

Power supply unit board

Supply unit		
Connector/terminal	Connection variant	Symbol
OUT 1 OUT 2	Relay Normally Open Contact	
OUT 3	Relay Changeover contact	

Optional boards

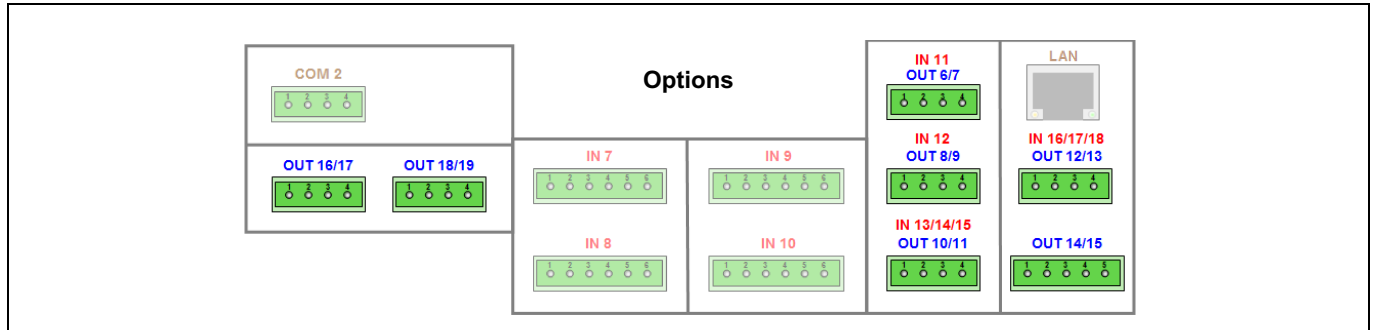

Slot	Option/connection variant	Symbol
OUT 6/7 OUT 8/9 OUT 10/11 OUT 12/13 OUT 14/15 OUT 16/17 OUT 18/19	Relay Changeover contact	
	2x relay Normally Open Contact ^a	
	Solid state relay triac 230 V/1 A	
	2x solid state relay PhotoMOS® 45 V/200 mA	
	Binary output 0/22 V	
	2x binary output 0/12 V	

^a Combining a mains voltage circuit with a protective low-voltage circuit on a 2-way normally open contact option is not admissible.

Mains power connection

Connector/terminal	Connection variant	Symbol
PWR IN	Mains power input	L1 ————○ L1 N ————○ N PE ————○ PE

Voltage supply outputs

Base unit

Connector/terminal	Connection variant	Symbol
DC ±5 V	Voltage supply (e.g. for ISFET sensors or JUMO digiLine)	+ ————○ 1 U ₌ - ————○ 2
DC 12 V / 24 V	Voltage supply (e.g. for external transmitters)	+ ————○ 26 U ₌ - ————○ 27

Power supply unit board

Connector/terminal	Connection variant	Symbol
PWR OUT	Mains voltage lead out	L1 ————○ L1 N ————○ N PE ————○ PE

Optional board

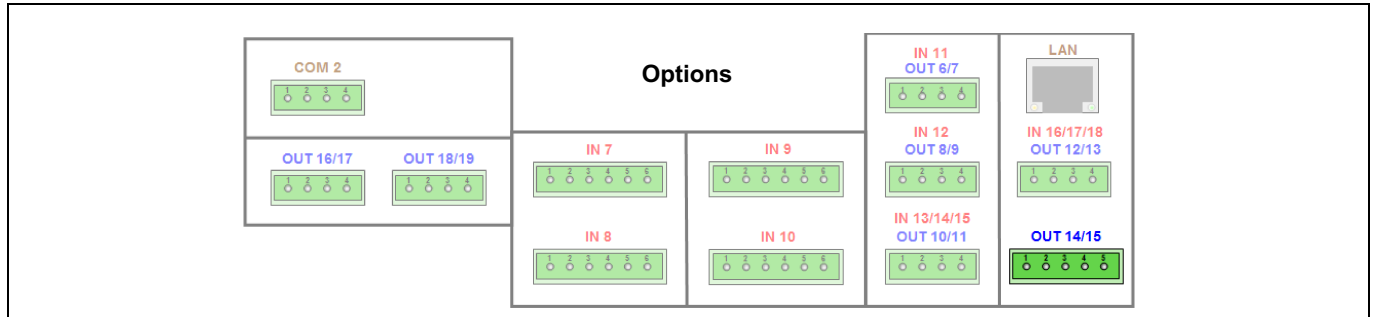

Slot	Connection variant	Symbol
OUT 14/15	Voltage supply DC 24 V for external transmitters 24 V	+ ———— ○ 1 U ₌ - ———— ○ 2
	DC ±5 V voltage supply (e.g. for ISFET sensors or JUMO digiLine)	+ ———— ○ 3 U ₌ ⊥ ———— ○ 4 - ———— ○ 5

Interfaces

Base unit

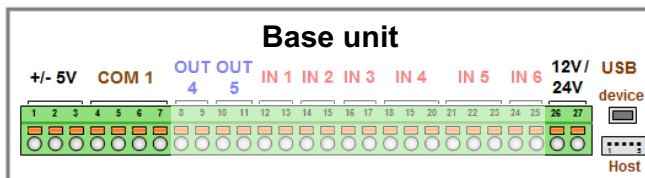

Connector/ terminal	Connection variant	Wire (color)	Potential	Terminal			Symbol
				DC ±5 V	DC 24 V	COM 1	
COM 1	RS422	RxD+	RxD+	-	-	4	
		RxD-	RxD-	-	-	5	
		TxD+	TxD+	-	-	6	
		TxD-	TxD-	-	-	7	
	RS485	RxD/TxD+	RxD/TxD+	-	-	6	
		RxD/TxD-	RxD/TxD-	-	-	7	
	Digital sensors (connection using the JUMO M12 master connecting cable)	A (gray)	RxD/TxD+	-	-	6	
		B (black)	RxD/TxD-	-	-	7	
		C (brown)	+5 V	1	-	-	
		D (blue)	GND	2	-	-	
E (blue)		GND	-	27	-		
F (white)		+24 V	-	26	-		
G (black with cable lug for connecting to the grounding)		Shield	Connection screw on cover plate of optional board in connection area				
<p>For connection of a JUMO digiLine bus line to operate digital sensors, JUMO offers 5-wire M12 digiLine Master connecting cable. A total of up to 6 digital sensors (JUMO ecoLine/tecLine or sensors with JUMO digiLine electronics) can be operated over a JUMO digiLine bus. The voltage supplies of DC 5 V and DC 24 V for the sensors on the bus are provided by the voltage supply outputs on the device (base unit or optional board).</p> <p>⇒ Chapter "Voltage supply outputs", page 34</p>							
USB device	USB device Type Mini-B (socket)	-	-	-	-	-	
USB host	Connection for USB host socket ^a Type A	-	-	-	-	-	

^a Use requires the USB host socket (see "Order Details" on page 46, Extra Code 269).



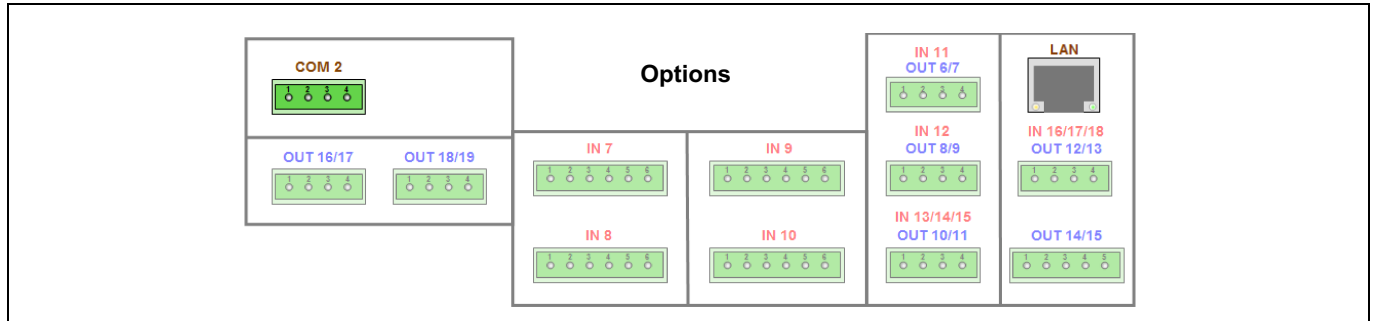

Optional boards

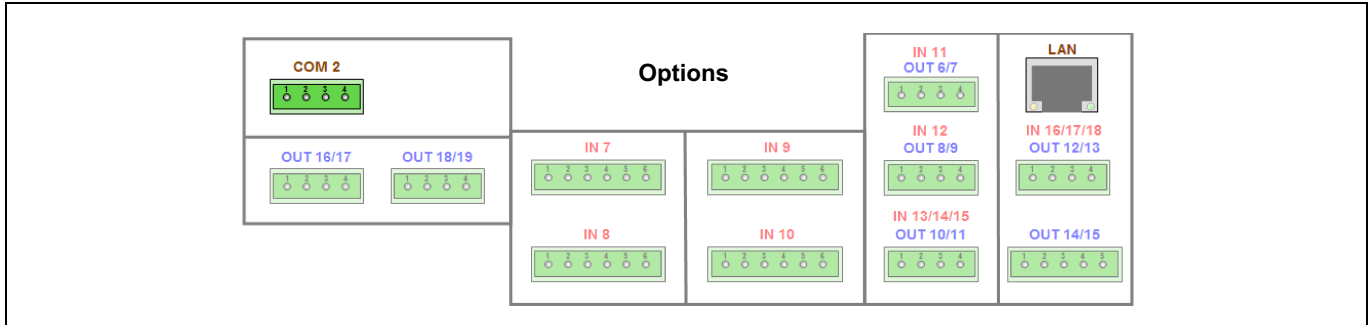

Slot	Option/ connection variant	Wire/pin (color)	Potential	Terminal			Symbol
				DC ±5 V	DC 24 V	COM 2	
COM 2	RS422 terminating resistors with DIP switches on op- tional board configu- rable	RxD+	RxD+	-	-	1	RxD+
		RxD-	RxD-	-	-	2	RxD-
		TxD+	TxD+	-	-	3	TxD+
		TxD-	TxD-	-	-	4	TxD-
	RS485 terminating resistors with DIP switches on op- tional board configu- rable	RxD/TxD+	RxD/TxD+	-	-	3	RxD/TxD+
		RxD/TxD-	RxD/TxD-	-	-	4	RxD/TxD-

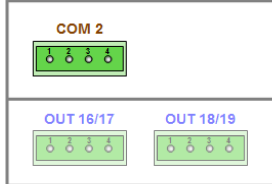
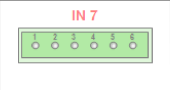
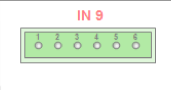

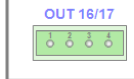
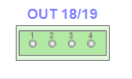
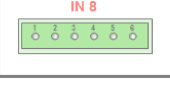
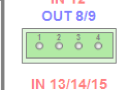
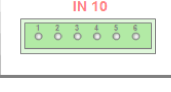
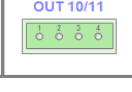
Slot	Option/ connection variant	Wire/pin (color)	Potential	Terminal			Symbol
				DC ±5 V	DC 24 V	COM 2	
COM 2	Digital sensors	A (gray)	RxD/TxD+	-	-	3	
	Connection to optional board: RS422/485 serial interface with JUMO M12 master connecting cable	B (black)	RxD/TxD-	-	-	4	
		C (brown)	+5 V	1	-	-	
		D (blue)	GND	2	-	-	
		E (blue)	GND	-	27	-	
		F (white)	+24 V	-	26	-	
		G (black with cable lug for connecting to the grounding)	Shield	Connection screw on cover plate of optional board in connection area			
<p>For connection of a JUMO digiLine bus line, JUMO offers 5-wire M12 digiLine master connecting cable. Up to 6 digital sensors (JUMO ecoLine/tecLine or sensors with JUMO digiLine electronics) can be operated over a JUMO digiLine bus. The voltage supplies of DC 5 V and DC 24 V for the sensors on the bus are provided by the voltage supply outputs on the device (base unit or optional board). ⇨ Chapter "Voltage supply outputs", page 34</p> <p>Located on the front of the serial interface RS422/485 optional board are DIP switches for setting the terminating resistors:</p> <p>with terminating resistors</p> <p>without terminating resistors</p>							
PROFIBUS-DP		3	RxD/TxD-P	-	-	-	
3 = RxD/TxD-P		5	DGND	-	-	-	
5 = DGND		6	VP	-	-	-	
6 = VP		8	RxD/TxD-N	-	-	-	
8 = RxD/TxD-N							

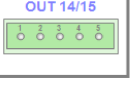
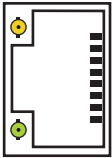
Options							
							
							
							
							
							
Slot	Option/ connection variant	Wire/pin (color)	Potential	Terminal			Symbol
				DC ±5 V	DC 24 V	COM 2	
LAN	Ethernet Type RJ 45 (socket)	-	-	-	-	-	

Galvanic isolation

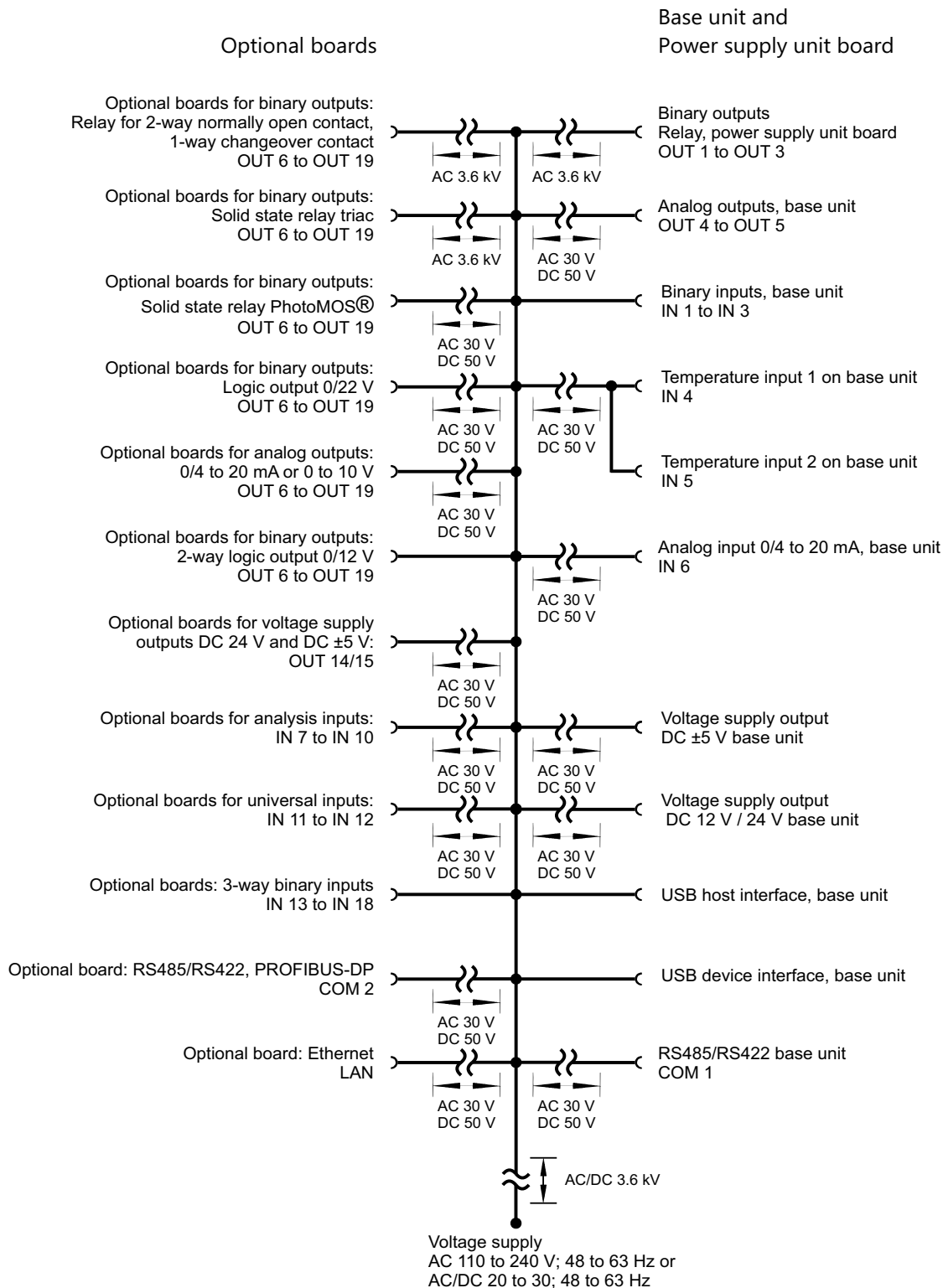

Warning:

When sensors are operated at a digital input without galvanic separation, and are being powered by an external power source, potential differences between the internal and external ground can lead to problems. Providing the voltage supply from the voltage supply outputs of the JUMO AQUIS touch S is preferable in such cases.

Dimensions

View from below
(cable entries)

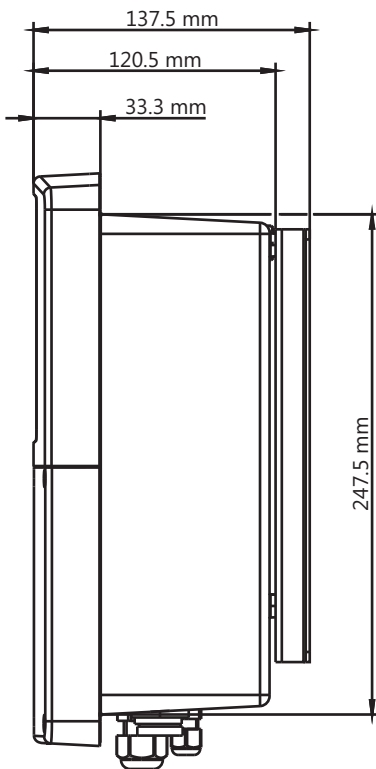
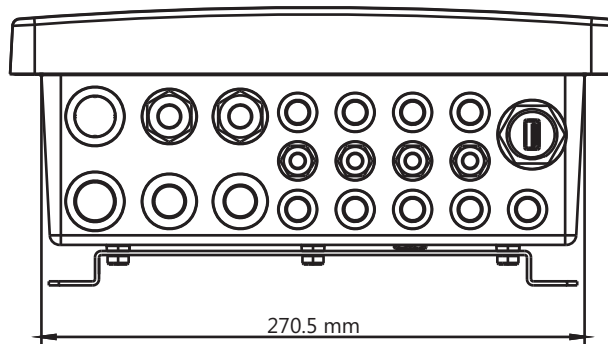

Side view

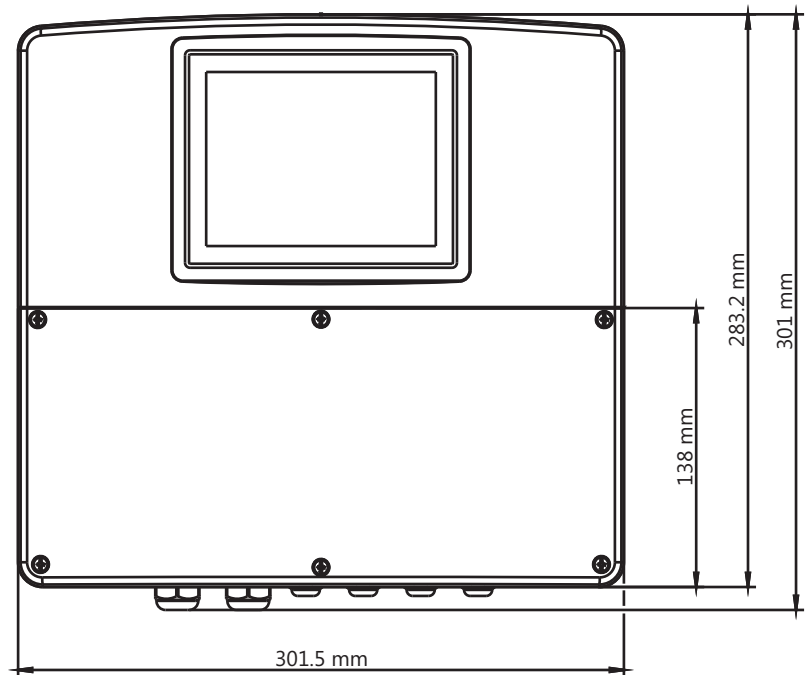

Front view

Surface mounting

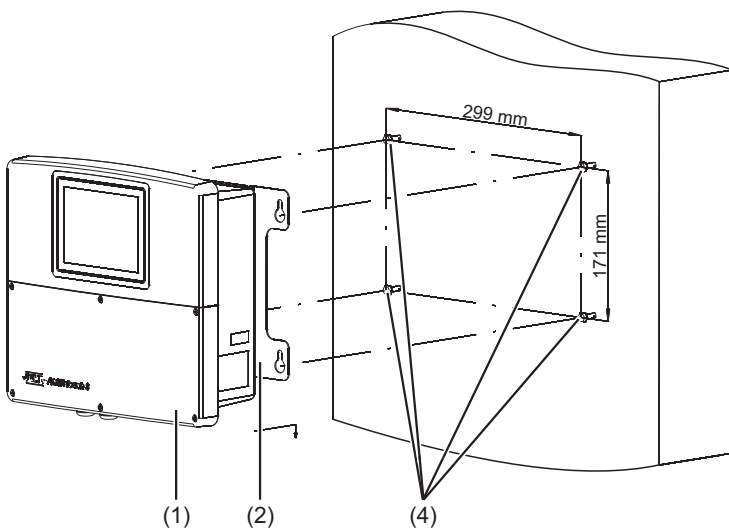
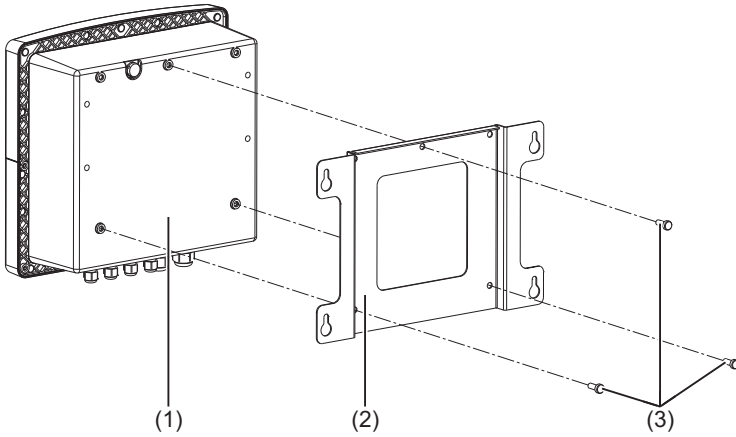

Drilling diagram

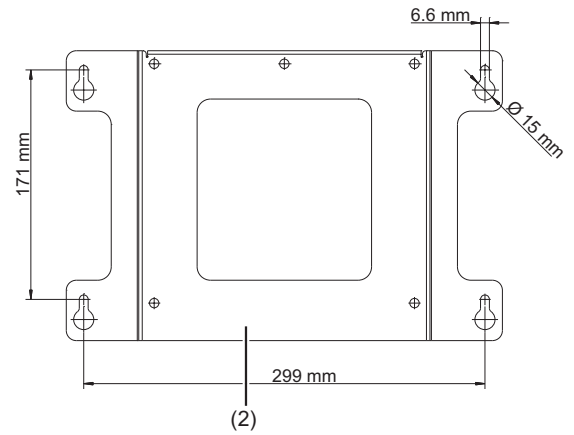

- (1) JUMO AQUIS touch S
- (2) Mounting plate
- (3) Self-tapping screws 60 × 16 TORX PLUS® 30IP (from the JUMO AQUIS touch S accessories pouch)
- (4) Fastening screws (hex-headed screws Ø 6 mm)
- (5) Weather protection canopy (part no. 00602404)

Surface mounting with weather protection canopy

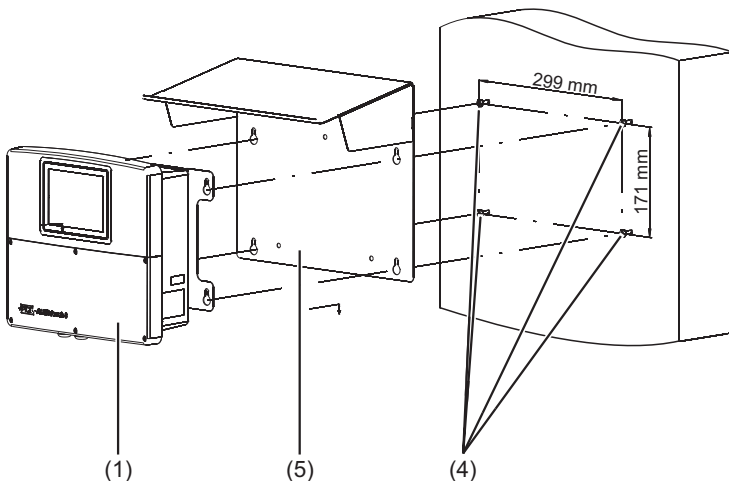

Pipe mounting

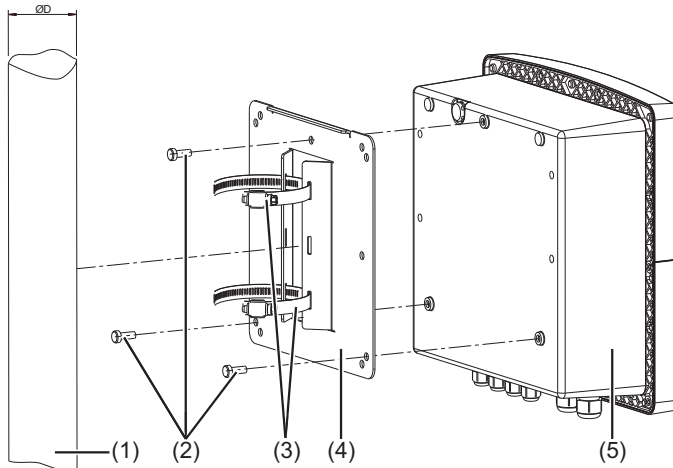

- (1) Pipe/mast (customer provision) with a diameter of 35 to 55 mm
- (2) Self-tapping screws 60 × 16 TORX PLUS® 30IP (from the AQUIS touch S accessories pouch)
- (3) Pipe clips from the pipe mounting kit (part no. 00602401)
- (4) Mounting plate for pipe mounting from the pipe mounting kit (part no. 00602401)
- (5) JUMO AQUIS touch S
- (6) Weather protection canopy (part no. 00602404)

Pipe mounting with weather protection canopy

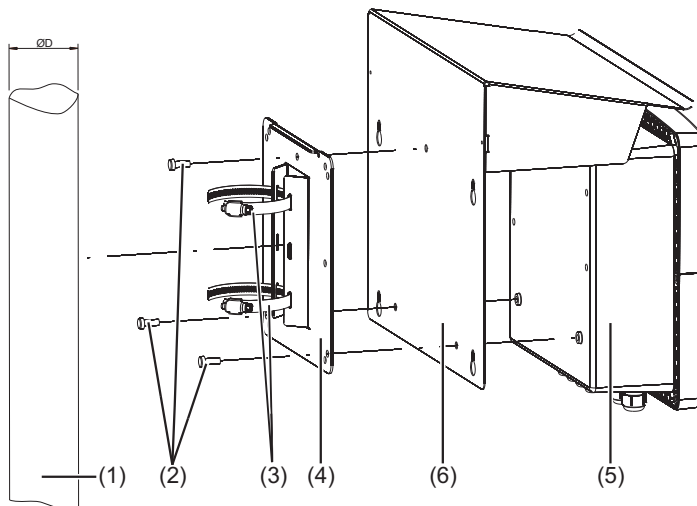

Panel mounting

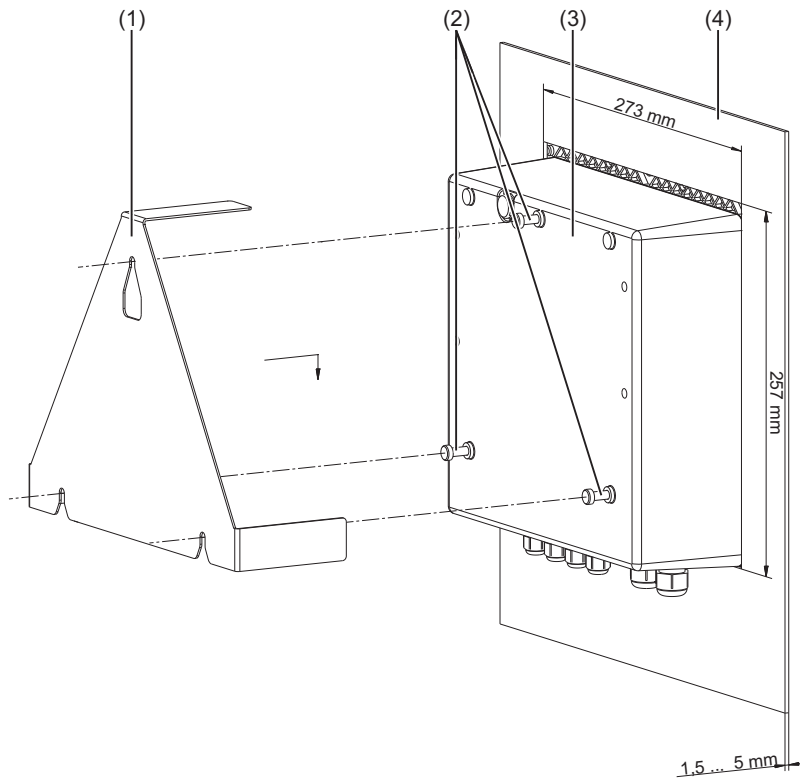

- (1) Fastening bracket from the panel mounting kit (part no. 00602403)
- (2) Self-tapping screws 60 × 16 TORX PLUS® 30IP (from the JUMO AQUIS touch S accessories pouch)
- (3) JUMO AQUIS touch S
- (4) Panel with device cutout 273 mm × 257 mm; max. material thickness of panel: 5 mm

Application examples

Cooling tower control

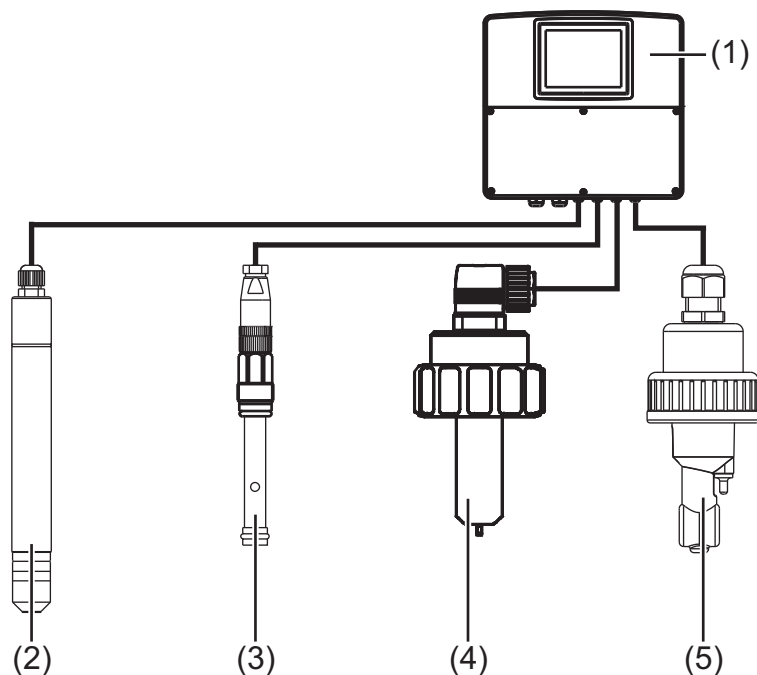

- (1) JUMO AQUIS touch S
- (2) Chlorine electrode (tecLine)
- (3) Flow monitor
- (4) Impeller sensor for flow measurement, Type 406020
- (5) Conductivity sensor (inductive)

Drinking water monitoring

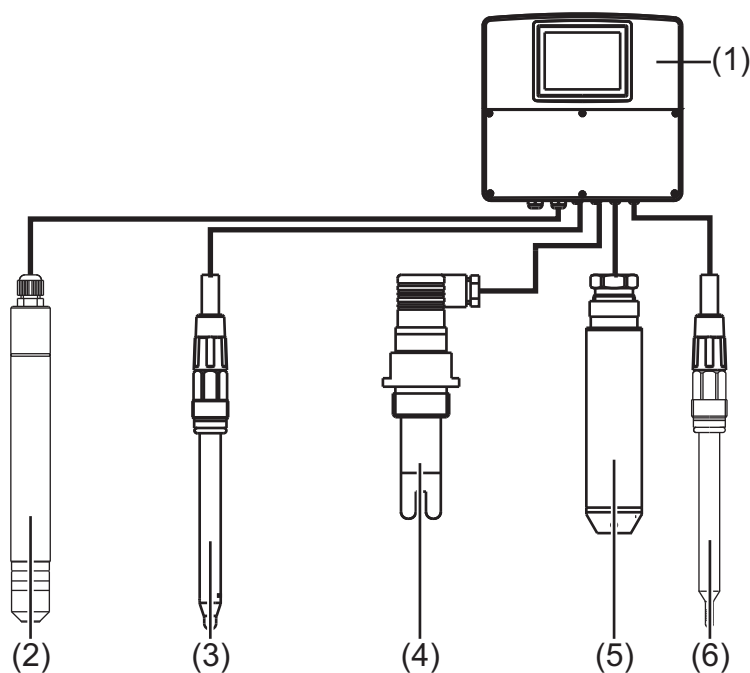

- (1) JUMO AQUIS touch S
- (2) Chlorine electrode (tecLine)
- (3) pH-single rod measuring chain
- (4) Conductivity sensor (conductive)
- (5) Level probe
- (6) Compensation thermometer, type 201085



Order Details

		Slot
	(1) Basic type	
202581	JUMO AQUIS touch S	
	(2) Version	
8	Standard with default settings	
9	Customer-specific configuration (specification in plain text)	
	(3) National language	
01	German	
02	English	
03	French	
	(4) Analysis input 1	IN 7
0	Not used	
1	pH/redox/NH ₃	
2	CR conductive conductivity measurement (2 and 4-pole)	
3	Ci inductive conductivity measurement	
	(5) Analysis input 2	IN 8
0	Not used	
1	pH/redox/NH ₃	
2	CR conductive conductivity measurement (2 and 4-pole)	
3	Ci inductive conductivity measurement	
	(6) Analysis input 3	IN 9
0	Not used	
1	pH/redox/NH ₃	
2	CR conductive conductivity measurement (2 and 4-pole)	
3	Ci inductive conductivity measurement	
	(7) Analysis input 4	IN 10
0	Not used	
1	pH/redox/NH ₃	
2	CR conductive conductivity measurement (2 and 4-pole)	
3	Ci inductive conductivity measurement	
	(8) Input/output 1	IN 11, OUT 6/7
00	Not used	
10	Universal input	
11	Relay (changeover contact)	
12	2× relays (normally open contact)	
13	Solid state relay triac 230 V, 1 A	
14	Logic output 0/22 V	
15	2× logic outputs 0/12 V	
16	Analog output	
17	2× solid state relay PhotoMOS®	

	(9) Input/output 2	IN 12, OUT 8/9
00	Not used	
10	Universal input	
11	Relay (changeover contact)	
12	2× relays (normally open contact)	
13	Solid state relay triac 230 V, 1 A	
14	Logic output 0/22 V	
15	2× logic outputs 0/12 V	
16	Analog output	
17	2× solid state relay PhotoMOS®	
	(10) Input/output 3	IN 13/14/15, OUT 10/11
00	Not used	
11	Relay (changeover contact)	
12	2× relays (normally open contact)	
13	Solid state relay triac 230 V, 1 A	
14	Logic output 0/22 V	
15	2× logic outputs 0/12 V	
16	Analog output	
17	2× solid state relay PhotoMOS®	
18	3× digital inputs	
	(11) Input/output 4	IN 16/17/18, OUT 12/13
00	Not used	
11	Relay (changeover contact)	
12	2× relays (normally open contact)	
13	Solid state relay triac 230 V, 1 A	
14	Logic output 0/22 V	
15	2× logic outputs 0/12 V	
16	Analog output	
17	2× solid state relay PhotoMOS®	
18	3× digital inputs	
	(12) Output 5	OUT 14/15
00	Not used	
11	Relay (changeover contact)	
12	2× relays (normally open contact)	
13	Solid state relay triac 230 V, 1 A	
14	Logic output 0/22 V	
15	2× logic outputs 0/12 V	
16	Analog output	
17	2× solid state relay PhotoMOS®	
19	Voltage supply output DC ±5 V, 24 V	
	(13) Output 6	OUT 16/17
00	Not used	
11	Relay (changeover contact)	
12	2× relays (normally open contact)	
13	Solid state relay triac 230 V, 1 A	
14	Logic output 0/22 V	
15	2× logic outputs 0/12 V	
16	Analog output	
17	2× solid state relay PhotoMOS®	



Scope of delivery

JUMO AQUIS touch S according to order details
Mini-DVD with JUMO PC setup program as demo version, Adobe Acrobat Reader, operating manual and data sheet in PDF format, GSD generator and JUMO PCC / PCA 3000 as demo version
JUMO AQUIS touch S accessories kit, part no. 00597460
Mounting plate for surface mounting, part no. 00597799
Terminal diagram sticker
Installation instructions in 2 volumes B 202581.4

Content of the JUMO AQUIS touch S accessories kit

6× M12 × 1.5 hexagon nut
6× gasket 10.2 × 14.5 × 1 for M12 cable fitting
6× M12 × 1.5 cable fitting
6× sealing plug for cable fitting M12
3× M16 × 1.5 hexagon nut
3× gasket 14.2 × 19.5 × 1 for M16 cable fitting
3× M16 × 1.5 cable fitting
3× plug for M16 cable fitting
26× cable tie 2.5 × 98 PA
3× self-tapping screw 60 × 16 TORX PLUS ^a 30IP (for panel mounting kit)
1× snap ferrite to suppress interference from the power supply cable to the device

^a TORX PLUS[®] is a registered trademark of Acument Intellectual Properties, LLC. USA.

Accessories

Order code	Type	Part no.
703571 (20258x)/10	Universal input	00581159
703571 (20258x)/213	Activation of the recording function	00581176
703571 (20258x)/214	Activate math and logic module	00581177
703571 (20258x)/11	Binary output relay (changeover contact)	00581160
703571 (20258x)/12	Binary outputs 2× relay (normally open contact)	00581162
703571 (20258x)/13	Solid state relay triac 230 V, 1 A	00581164
703571 (20258x)/14	Logic output 0/22 V	00581165
703571 (20258x)/15	2× logic output 0/12 V	00581168
703571 (20258x)/16	Analog output	00581169
703571 (20258x)/17	Digital outputs 2× solid state relay PhotoMOS®	00581171
703571 (20258x)/54	Serial interface RS422/485 for Modbus RTU and JUMO digiLine ^a	00581172
703571 (20258x)/64	PROFIBUS-DP	00581173
703571 (20258x)/08	Ethernet	00581174
20258x/3	Analysis input Ci for inductive conductivity	00584265
20258x/2	Analysis input CR for resistive conductivity	00584263
20258x/1	Analysis input pH/Redox/NH ₃	00584264
20258x/18	Digital inputs 3× potential-free contact	00592962
20258x/19	Voltage supply output DC ±5 V, 24 V	00592963
202581/269	USB host socket (IP67)	00608741
	Ethernet RJ-45 connector for self-assembly (4-pole) (PG209791)	00594813
	USB flash drive 2.0 (2 GB) ^b	00505592
	USB cable, A-connector on Mini B-connector, length 3 m	00506252
	Full configuration kit, cable fittings	00597461
	Panel mounting kit	00602403
	Pipe-mounted kit	00602401
	Protective roof kit	00602404
	JUMO PC setup program AQUIS touch S/P, (PG202599)	00594355
	JUMO PCA3000/PCC software package ^c	00431884

^a The accessories required to install a JUMO digiLine bus can be found in the type sheets and operating manual for the JUMO digiLine components (e.g. JUMO digiLine pH/ORP/T type 202705 or JUMO digiLine hub type 203590).

^b The USB flash drive indicated has been tested and is designed for industrial applications. No liability is assumed for other brands.

^c Communication and evaluation software for stored recording function measurement data

Notes on the trademark

PhotoMOS® is a registered trademark of Panasonic.

Motorola® is a registered trademark of Motorola Trademark Holdings, LLC, Libertyville, US

Intel® is a registered trademark of Intel Corp., Santa Clara California, US

Microsoft® is a registered trademark of Microsoft Corp., Redmond Washington, US.

Microsoft® is a registered trademark of Microsoft Corp., Redmond Washington, US.

Silverlight® is a registered trademark of Microsoft Corp., Redmond Washington, US.

TORX PLUS® is a registered trademark of Acument Intellectual Properties, LLC. USA.